

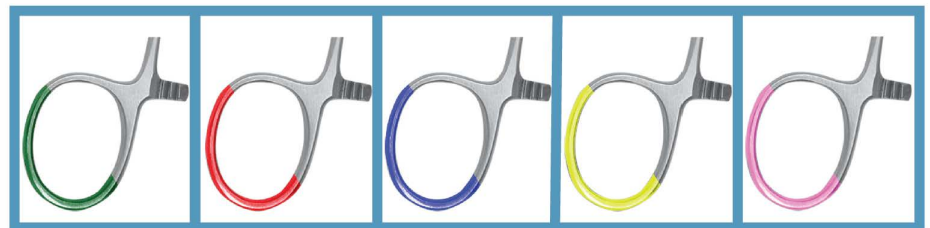

# TATA

**SYMBOL OF QUALITY**



**GREEN**

**RED**

**BLUE**

**YELLOW**

**PINK**





# ABOUT US

Tata Surgical was established in 1984 and started manufacturing of re-usable medical instruments at small scale with skillful workers. Due to production of high quality surgical and dental instruments, soon it becomes popular among the potential buyers of Europe; England, Germany, France, Spain, Holland, Switzerland and Italy.

Tata Surgical rapidly grew and gained a good name among those countries with better quality, competitive prices and reliable delivery services.

In 2005, Tata Surgical started producing single-use surgical instruments as well and become a popular company among the suppliers of SU instruments to Europe. Tata surgical got its CE certification of Class IIa & IIb from BVQI and then SGS UK.

In 2010, Tata Surgical started production of electro-surgical instruments, bipolar, mono-polar forceps and electrodes, disposable and re-usable with good quality.



[sales@neuindustries.com](mailto:sales@neuindustries.com)

[www.neuindustries.com](http://www.neuindustries.com)



- TABH 1100 STR 125mm
- TABH 1111 CVD 125mm
- TABH 2100 STR 200mm
- TABH 2111 CVD 200mm

HALSTED MOSQUITO ARTERY FORCEPS



- TABM-2355/2 125mm
- TABM-2355/1 140mm
- TABM-2355 150mm
- TABM-2200 160mm
- TABM-2366 185mm
- TABM-2377 200mm
- TABM-2388 235mm
- TABM-2400 265mm
- TABM-2411 160mm
- TABM-2422 190mm

MAYO-HEGAR NEEDLE HOLDER (MEDIUM)



- TABF 0466 200mm
- TABF 0477 200mm
- TABF 0588 265mm
- TABF 0599 265mm
- TABF 0588/1 250mm
- TABF 0599/1 250mm

GROSS MAIER SPONGE FORCEPS

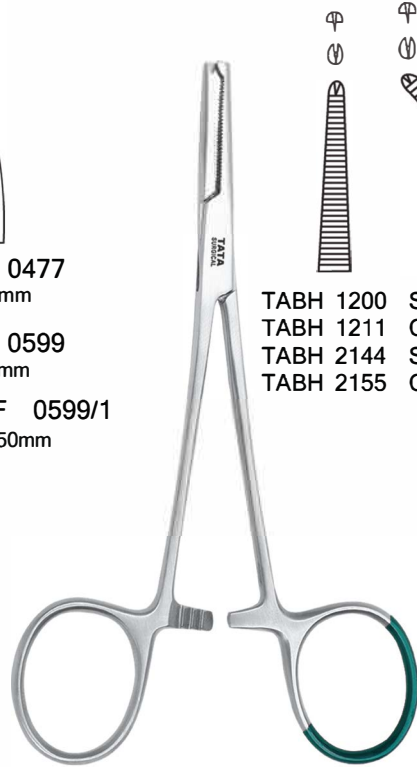

- TABH 1200 STR 125mm
- TABH 1211 CVD 125mm
- TABH 2144 STR 200mm
- TABH 2155 CVD 200mm

HALSTED MOSQUITO KOCHER FORCEPS 1X2 Teeth



TABH-4100 PEAN ARTERY FORCEPS TUBING CLUMP 125mm

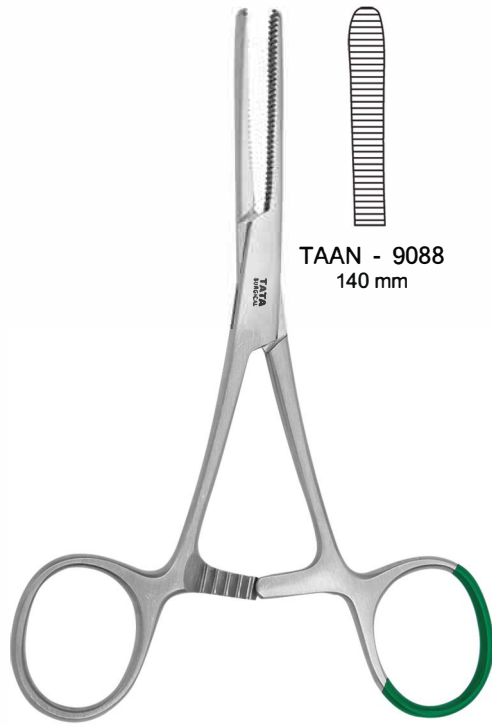

TAAN - 9088  
140 mm

TUBING CLAMP  
HEAVY PATTERN LONG RATCHET  
KLINIKUM BERLIN



PEAN KOCHER FORCEPS

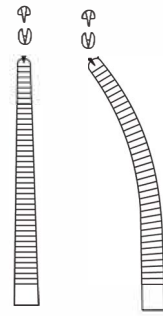

- |             |     |       |
|-------------|-----|-------|
| TABH 6122   | STR | 130mm |
| TABH 6144   | STR | 140mm |
| TABH 6155   | CVD | 140mm |
| TABH 6300   | STR | 150mm |
| TABH 6311   | CVD | 150mm |
| TABH 6422/1 | STR | 160mm |
| TABH 6433/1 | CVD | 160mm |
| TABH 6444/1 | STR | 185mm |
| TABH 6455/1 | CVD | 185mm |
| TABH 6466/1 | STR | 200mm |
| TABH 6477/1 | CVD | 200mm |
| TABH 6488/1 | STR | 225mm |
| TABH 6499/1 | CVD | 225mm |
| TABH 6500/1 | STR | 240mm |
| TABH 6511/1 | CVD | 240mm |
| TABH 6522/1 | STR | 260mm |
| TABH 6533/1 | CVD | 260mm |
| TABH 6544/1 | STR | 280mm |
| TABH 6555/1 | CVD | 280mm |
| TABH 6588/1 | STR | 350mm |
| TABH 6599/1 | CVD | 350mm |



TABM 2044

DERF NEEDLE HOLDER  
125 mm



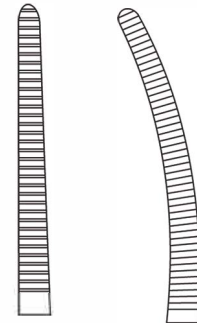

ROCHESTER PEAN FORCEPS

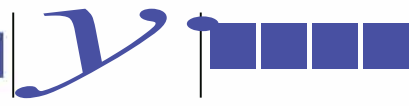

- |           |     |        |
|-----------|-----|--------|
| TABH 4222 | STR | 130 mm |
| TABH 4122 | CVD | 130 mm |
| TABH 4244 | STR | 140 mm |
| TABH 4255 | CVD | 140 mm |
| TABH 4422 | STR | 160 mm |
| TABH 4433 | CVD | 160 mm |
| TABH 4444 | STR | 180 mm |
| TABH 4455 | CVD | 180 mm |
| TABH 4466 | STR | 200 mm |
| TABH 4477 | CVD | 200 mm |
| TABH 4488 | STR | 225 mm |
| TABH 4499 | CVD | 225 mm |
| TABH 4500 | STR | 240 mm |
| TABH 4511 | CVD | 240 mm |
| TABH 4722 | STR | 265 mm |
| TABH 4733 | CVD | 265 mm |
| TABH 4566 | STR | 350 mm |
| TABH 4577 | CVD | 350 mm |





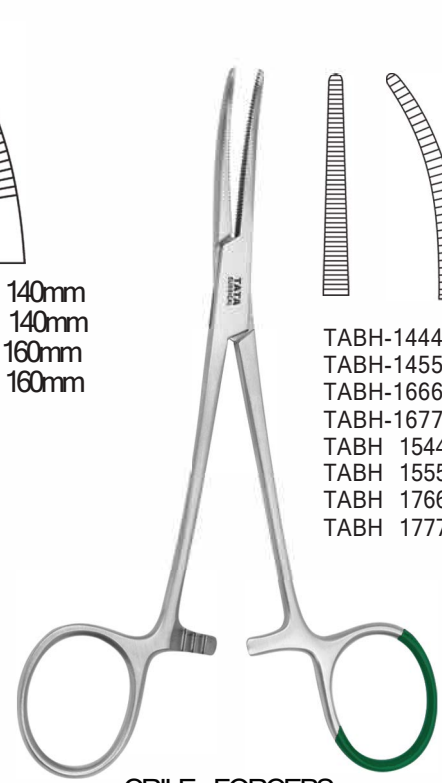

KELLY FORCEPS

	TABH 1344	STR	140mm
	TABH 1355	CVD	140mm
	TABH 1344/1	STR	160mm
	TABH 1355/1	CVD	160mm



CRILE FORCEPS

	TABH-1444	140 mm	STR
	TABH-1455	140 mm	CVD
	TABH-1666	160 mm	STR
	TABH-1677	160 mm	CVD
	TABH 1544	140 mm	STR 1X2 TEETH
	TABH 1555	140 mm	CVD 1X2 TEETH
	TABH 1766	160 mm	STR 1X2 TEETH
	TABH 1777	160 mm	CVD 1X2 TEETH



BABCOCK ORGAN & TISSUE GRASPING FORCEPS  
TAEA-0300 140 mm  
TAEA-0311 170 mm



GROSS SPONGE FORCEPS

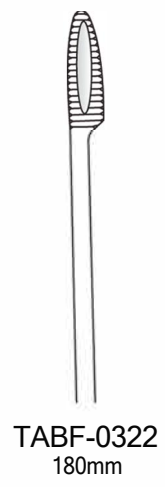

TABH 2277 CVD 240mm  
CRAFORD ARTERY FORCEPS (MODIFIED)



MICRO MOSQUITO FORCEPS

TABH 1088 125 mm  
 TABH 1044 100 mm  
 TABH 1099 125 mm  
 TABH 1055 100 mm

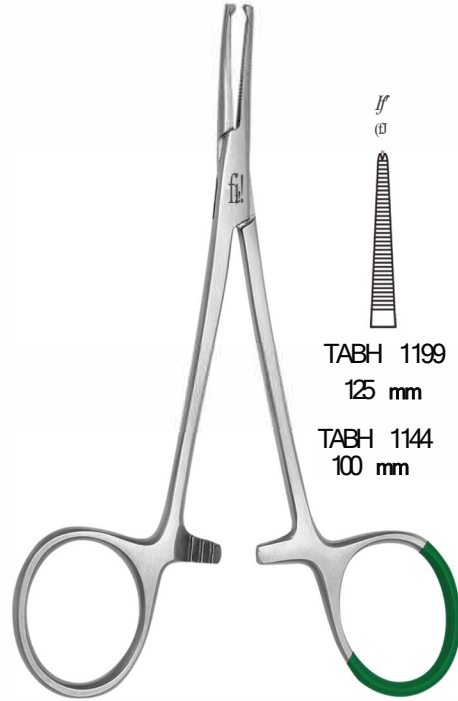

MICRO MOSQUITO KOCHER FORCEPS  
 1X2 Teeth

TABH 1199 125 mm  
 TABH 1144 100 mm  
 TABH 1188 125 mm  
 TABH 1155 100 mm



TABD 9933  
 CVD

TABD 9922  
 STR

STIEGLITZ SPLINTER FORCEPS  
 14CM

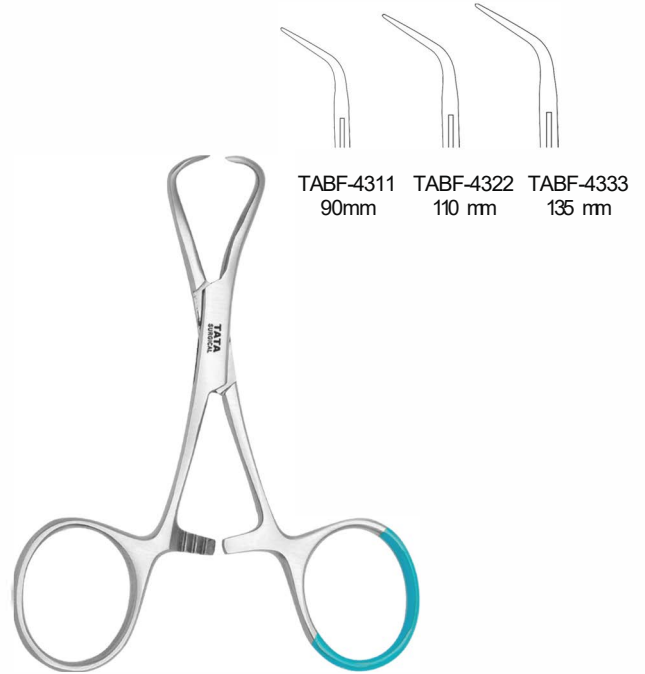

TABF-4311 90mm  
 TABF-4322 110 mm  
 TABF-4333 135 mm

BACKHAUS TOWEL CLAMP



TUBING CLUMP FORCEPS  
TAAN-9099 165 mm



SMOOTH JAWS  
TABF 1200  
245 mm



TABF 1122  
180 mm  
TABF 1222  
245 mm  
TABF 1222/1  
255 mm

TABF 1355  
320mm



FOERSTER SPONGE HOLDING FORCEPS

TABF 1133  
180 mm  
TABF 1233  
245 mm  
TABF 1233/1  
255 mm  
TABF 1366  
320mm



SMOOTH JAWS  
TABF 1211  
245 mm



TABF 1166 18CM  
TABF 1188 25CM

RAMPLEY SPONGE  
FORCEPS



TUBING CLUMP FORCEPS  
TAAN-9111 180 mm  
TAMD 6522 150 mm

TAAN 9122 18CM  
TAAN 9133 20CM  
SERRATED JAW  
WITH OUT CLIP



TABN-7500  
MICHEL CLIP APPLYING &  
REMOVING FORCEPS  
125 mm



er  
TAAN-3799 150 mm  
TAAN-3800 200 mm  
TAAN-3811 250 mm

MAGILL FORCEPS



TABM-4066 145 mm  
 TABM-4077 170 mm  
 MATHIEU -STILLE NEEDLE HOLDER

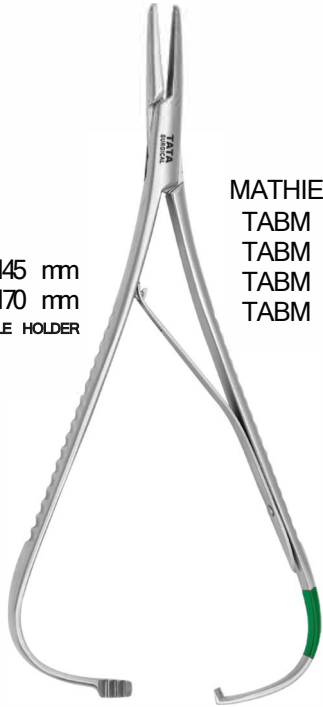

MATHIEU NEEDLE HOLDER

j

MATHIEU NEEDLE HOLDER  
 TABM 3600 140 mm  
 TABM 3600/3 150mm  
 TABM 3611 170 mm  
 TABM 3622 200 mm



SMAHA MATHIEU MOSQUITO  
 FINE POINT  
 TABM 3600/1 140 mm  
 TABM 3611/1 170 mm  
 TABM 3622/1 200 mm



SMAHA MATHIEU MOSQUITO  
 FINE POINT CVD  
 TABM 3600/2 140 mm  
 TABM 3611/2 170 mm  
 TABM 3622/2 200 mm

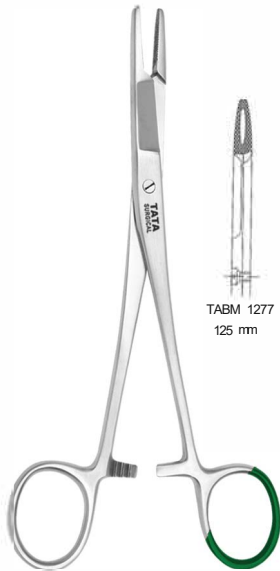

OLSEN-HEGAR NEEDLE HOLDER

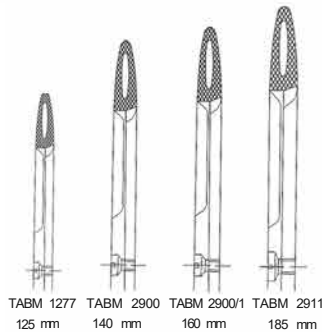

TABM 1277 125 mm  
 TABM 2900 140 mm  
 TABM 2900/1 160 mm  
 TABM 2911 185 mm



ROCHESTER-OCHSNER FORCEPS  
 1X2 Teeth

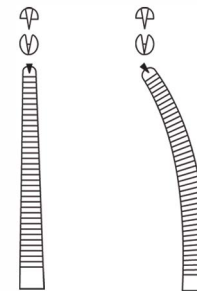

TABH 6188 140mm  
 TABH 6422 160mm  
 TABH 6444 185mm  
 TABH 6466 200mm  
 TABH 6488 225mm  
 TABH 6500 240mm  
 TABH 6199 140mm  
 TABH 6433 160mm  
 TABH 6455 185mm  
 TABH 6477 200mm  
 TABH 6499 225mm  
 TABH 6511 240mm



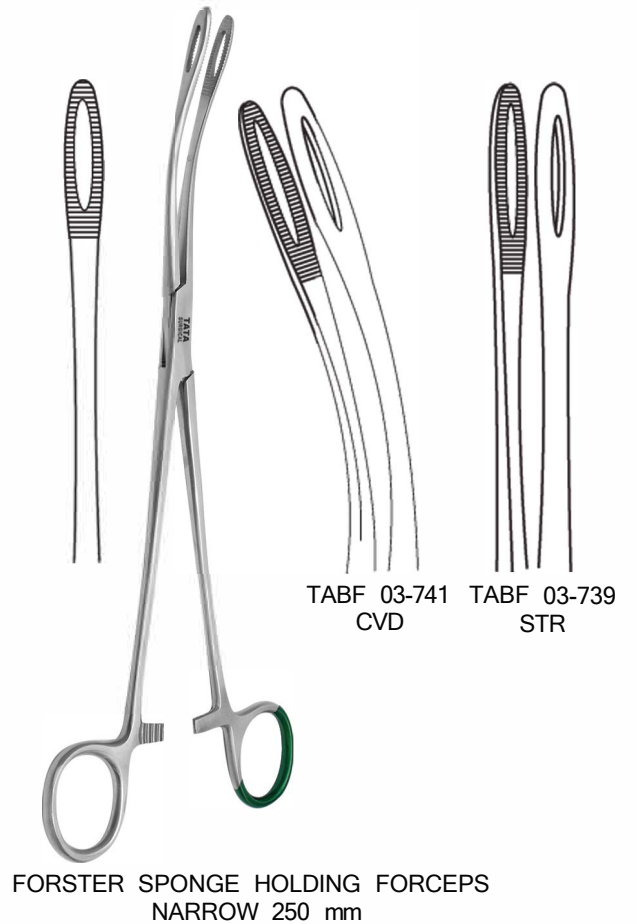
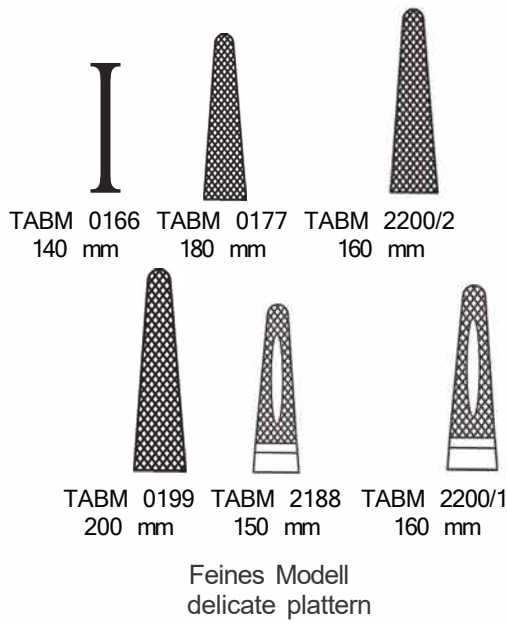
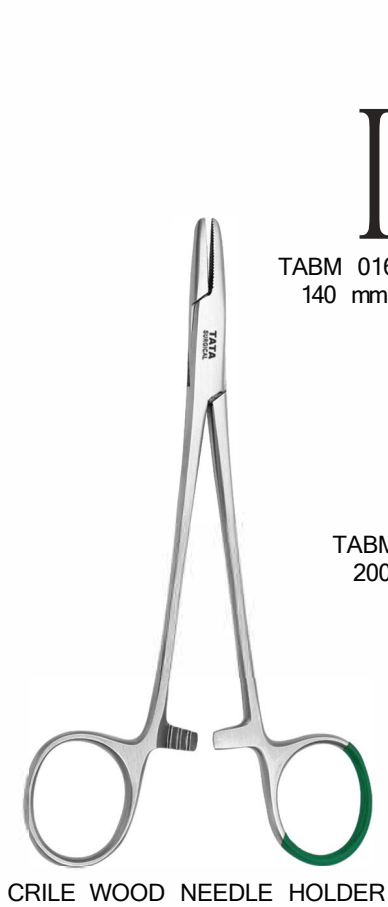
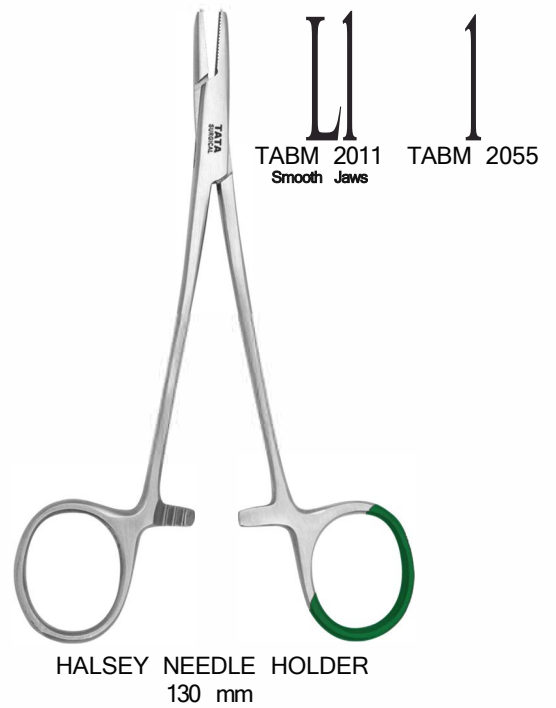
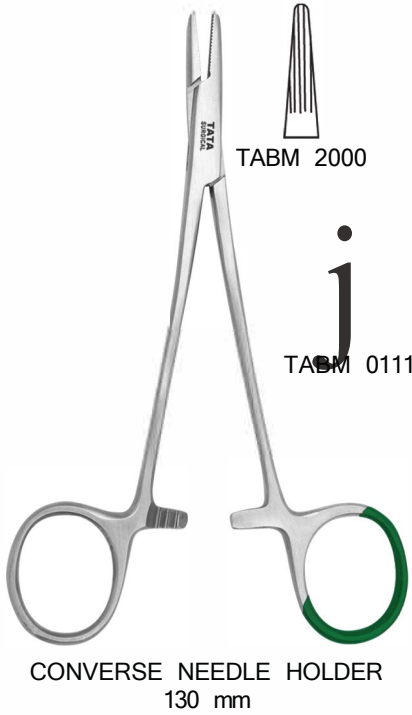



# SINGLE USE INSTRUMENTS



PEAN DRESSING FORCEPS

- TABH 3022 125 mm STR
- TABH 3022/1 125 mm CVD
- TABH 3044 140 mm STR
- TABH 3044/1 140 mm CVD
- TABH 3055 160 mm STR
- TABH 3055/1 160 mm CVD

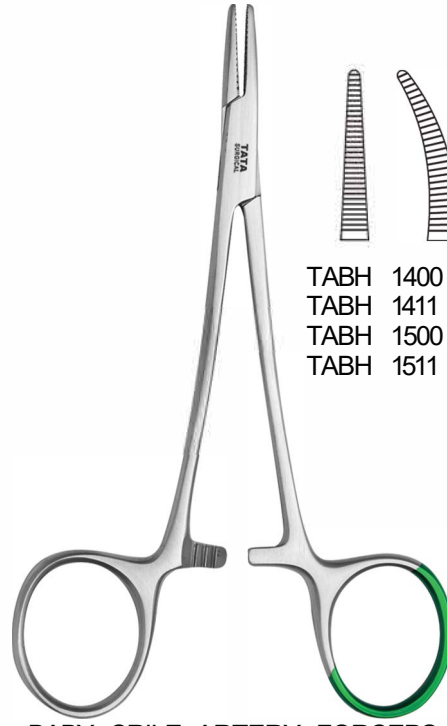

BABY CRILE ARTERY FORCEPS  
140mm

- TABH 1400 STR
- TABH 1411 CVD
- TABH 1500 CVD ( KOCHER )
- TABH 1511 STR ( KOCHER )

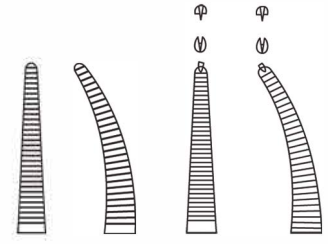

- TABF 0600 220mm STR
- TABF 0611 220mm CVD
- TABF 0622 265mm STR
- TABF 0633 265mm CVD



COLLIN HEMOSTATIC FORCEPS  
170mm

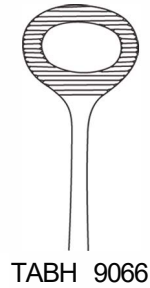

TABH 9066

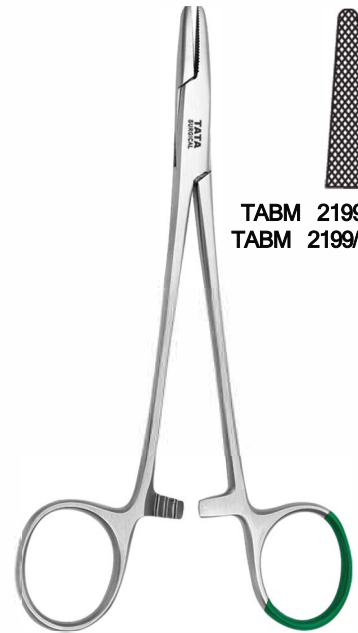

CRILE-MURRAY NEEDLE HOLDER

- TABM 2199 150mm
- TABM 2199/1 160mm





TAOF 4066  
TILLEY NASAL DRESSING FORCEPS  
13CM

TAOF 4077  
TILLEY NASAL DRESSING FORCEPS  
14CM

TAOF 4088 / 4111  
TILLEY NASAL DRESSING FORCEPS  
16CM

TAOF 4099  
TILLEY NASAL DRESSING FORCEPS  
20CM

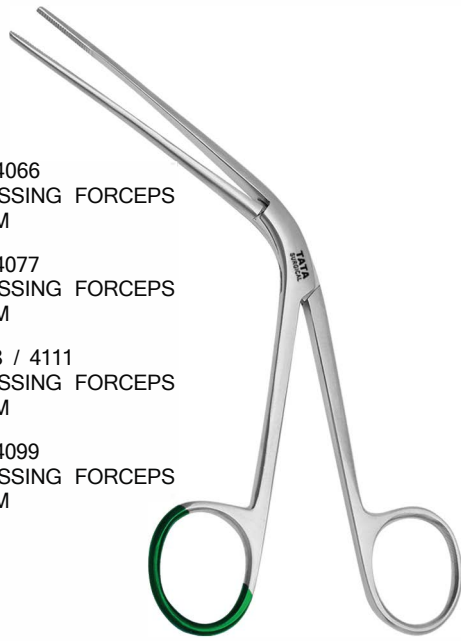

TABM 0133  
BABY CRILE WOOD NEEDLE HOLDER  
150mm



TAE0 1055 175mm  
TAE0 1255 255mm  
POZZI UTERINE TENACULUM FORCEPS



TAOF 4100-1  
HARTMANN EAR FORCEPS STR 8CM SHAFT LENGTH  
4MM TIP.

TAOF 4100  
HARTMANN EAR FORCEPS STR 8CM SHAFT LENGTH  
5MM TIP.

TAOF 4444  
HARTMANN EAR FORCEPS STR 8CM SHAFT LENGTH  
6MM TIP.

TAOF 4144  
HARTMANN EAR FORCEPS STR 8CM SHAFT LENGTH  
7MM TIP.





**SINGLE USE INSTRUMENTS**



TABJ 0088  
MICRO ADSON DISSECTING  
FORCEPS CVD 14CM

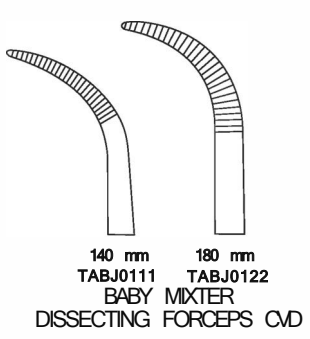

140 mm TABJ0111  
180 mm TABJ0122  
BABY MIXTER  
DISSECTING FORCEPS CVD

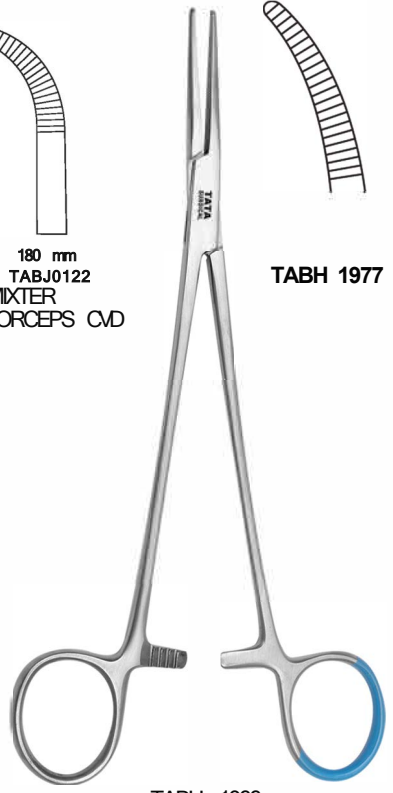

TABH 1966  
BIRKETT ARTERY FORCEPS  
18.5CM STR



TABH 1977 CVD



TABH 1600  
LERICHE ARTERY FORCEPS  
150 mm



TABJ 0099  
BABY OVERHOLT FORCEPS  
CVD 135 mm



TABH 9577  
SCHNIDT ARTERY FORCEPS  
CVD 190 mm



TAEA 0144 155mm 3X4 TEETH  
TAEA 0155 155mm 4X5 TEETH  
TAE0 0166 155mm 5X6 TEETH  
TAEA 0200 200mm 6X7 TEETH  
ALLIS TISSUE GRASPING FORCEPS





TAFa 0066 13CM LIGHT WEIGHT  
 TAFa 0077 14CM STRONG PATTERN  
 LABORDE TRACHEAL DILATOR DOUBLE SPRING



TAFa 0055  
 TRACHEAL DILATOR TROUSSEAU  
 12CM

I  
 TABM 2211/1  
 LIGHT



CRILE WOOD NEEDLE HOLDER  
 140 mm

TABM 2211/2  
 VERY DELICATE



KILNER NEEDLE HOLDER

I  
 TABM 2111 135MM  
 TABM 2111/1 140MM



TABF 4655 115 mm  
 TABF 4644 140 mm  
 TOWEL CLAMP for PAPER CLOTHS



- TABH 3322 STR 130 mm
- TABH 3333 CVD 130 mm
- TABH 3344 STR 150 mm
- TABH 3355 CVD 150 mm
- TABH 3366 STR 170 mm
- TABH 3377 CVD 170 mm
- TABH 3388 STR 200 mm
- TABH 3399 CVD 200 mm
- TABH 3300 STR 230 mm
- TABH 3611 CVD 230 mm

SPENCER WELLS ARTERY FORCEPS



TAOF 3000  
QUIRE EAR FORCEPS  
FOR REMOVAL OF FOREIGN BODIES 90mm



TABM-5633

CASTROVIEJO NEEDLE HOLDER  
145 mm STR with catch



TAFD-0766 STR 160mm  
TAFD-0799 CVD 160mm

MICRO NEEDLE HOLDER  
With out catch



TAOC 4822 STR

NOYES EYE SCISSORS 125mm  
TAOC 4822/1 CVD

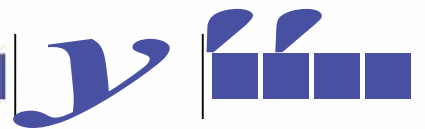

TAVF 4699  
VASECTOMY FINE MOSQUITO FORCEPS  
125MM CVD



TAVF 4655 DIA 4.7MM  
TAVF 4666 DIA 3.0MM  
VASECTOMY RING FORCEPS  
140MM



TAFH 4600/1  
NIPPER PLIER DELICATE  
12CM ( WIRE CUTTER)

7  
TABT 9444/1  
10x6 mm

7  
TABT9444/2  
15x6 mm

7  
TABT 9433/1  
10x6mm

7  
TABT9433/2  
15x6mm

7  
TABT 9444/3  
17x6 mm

7  
TABT9444/4  
20x6 mm

7  
TABT 9433/3  
17x6 mm

II  
TABT9433/4  
20x6mm

7  
TABT 9444/5  
22x8 mm

7  
TABT 9444/6  
25x8 mm

7  
TABT9433/5  
22x8 mm

7  
TABT9433/6  
25x8 mm



TABT 9444/7  
30x8 mm



TABT9433/7  
30x8 mm

LANGEN BECK MANNERFEL T  
RETRACTOR ROUND HANDLE  
15 CM

MINI LANGENBECK  
RETRACTOR PLAN HANDLE 15 CM

TABT 0099  
JACKSON TRACHEAL RETRACTOR  
DOUBLE ENDED 18CM





TABC 8600 115mm TABC 8611 140mm TABC 8488 150mm TABC 8622 180mm TABC 8633 200mm

LISTER BANDAGE SCISSORS



SURGICAL SCISSORS SH /BL

TABC 3200	STR	105MM
TABC 4200	CVD	105MM
TABC 3211	STR	115MM
TABC 4211	CVD	115MM
TABC 3211/1	STR	120MM
TABC 4211/1	CVD	120MM
TABC 3233	STR	130MM
TABC 4233	CVD	130MM
TABC 3244	STR	140MM
TABC 4244	CVD	140MM
TABC 3255	STR	150MM
TABC 4255	CVD	150MM
TABC 3266	STR	160MM
TABC 4266	CVD	160MM
TABC 3277	STR	170MM
TABC 4277	CVD	170MM
TABC 3288	STR	185MM
TABC 4288	CVD	185MM
TABC 3330	STR	200MM



IRIS & LIGATURE SCISSORS

TABC 0566	STR	90MM
TABC 0577	CVD	90MM
TABC 0600	STR	105MM
TABC 0611	CVD	105MM
TABC 1100	STR	110MM
TABC 1111	CVD	110MM
TABC 1066	STR	115MM
TABC 1077	CVD	115MM
TABC 0644	STR	120MM
TABC 0655	CVD	120MM
TABC 1400	STR	130MM
TABC 1411	CVD	130MM



DELICATE SCISSORS 90 mm

TABC-1000 STR TABC-1011 CVD





SURGICAL SCISSORS Blunt /Blunt

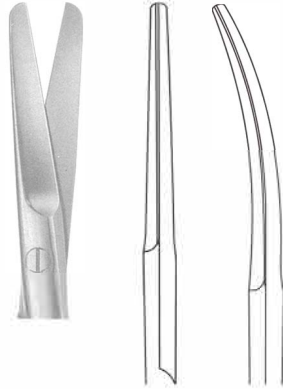

- |           |     |       |
|-----------|-----|-------|
| TABC 3122 | STR | 115mm |
| TABC 4111 | CVD | 115mm |
| TABC 3133 | STR | 130mm |
| TABC 4133 | CVD | 130mm |
| TABC 3144 | STR | 140mm |
| TABC 4144 | CVD | 140mm |
| TABC 3155 | STR | 150mm |
| TABC 4155 | CVD | 150mm |
| TABC 3166 | STR | 160mm |
| TABC 4166 | CVD | 160mm |
| TABC 3177 | STR | 175mm |
| TABC 4177 | CVD | 175mm |
| TABC 3188 | STR | 180mm |
| TABC 4188 | CVD | 180mm |



SURGICAL SCISSORS Sharp /Sharp

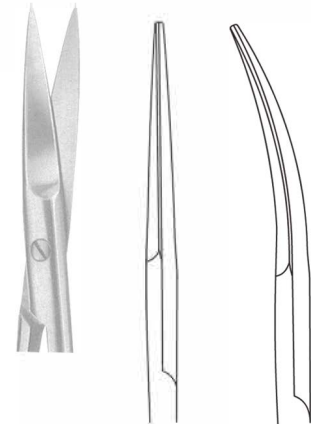

- |           |     |       |
|-----------|-----|-------|
| TABC 3411 | STR | 115MM |
| TABC 4411 | CVD | 115MM |
| TABC 3433 | STR | 130MM |
| TABC 4433 | CVD | 130MM |
| TABC 3444 | STR | 140MM |
| TABC 4444 | CVD | 140MM |
| TABC 3455 | STR | 150MM |
| TABC 4455 | CVD | 150MM |
| TABC 3466 | STR | 160MM |
| TABC 4466 | CVD | 160MM |



SPENCER / STITCH / SUTURE SCISSORS

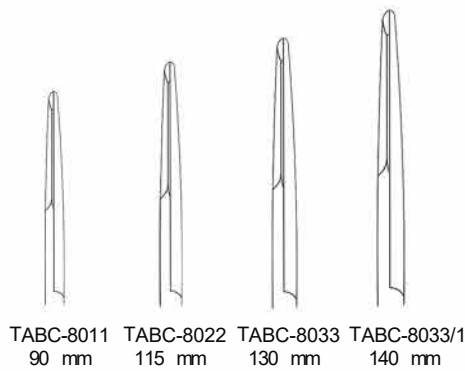

- |           |           |           |             |
|-----------|-----------|-----------|-------------|
| TABC-8011 | TABC-8022 | TABC-8033 | TABC-8033/1 |
| 90 mm     | 115 mm    | 130 mm    | 140 mm      |



REYNOLDS / STEVENS /JAMESON DISSECTING SCISSORS FINE ( SHARP)

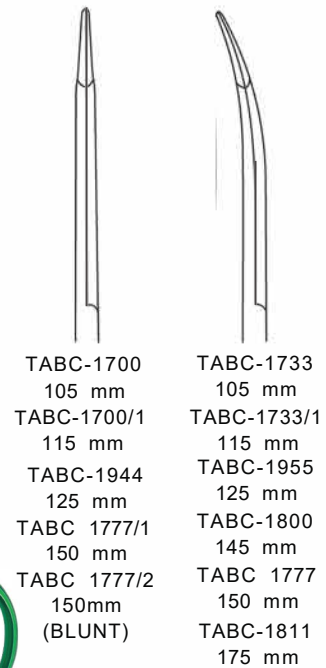

- |               |             |
|---------------|-------------|
| TABC-1700     | TABC-1733   |
| 105 mm        | 105 mm      |
| TABC-1700/1   | TABC-1733/1 |
| 115 mm        | 115 mm      |
| TABC-1944     | TABC-1955   |
| 125 mm        | 125 mm      |
| TABC 1777/1   | TABC-1800   |
| 150 mm        | 145 mm      |
| TABC 1777/2   | TABC 1777   |
| 150mm (BLUNT) | 150 mm      |
|               | TABC-1811   |
|               | 175 mm      |



TABC7966 TABC 7977  
135 mm 160 mm

UMBILICAL CORD SCISSORS  
(BUSCH) SIDEWARDS CVD



METZENBAUM (fino) DISSECTING  
SCISSORS

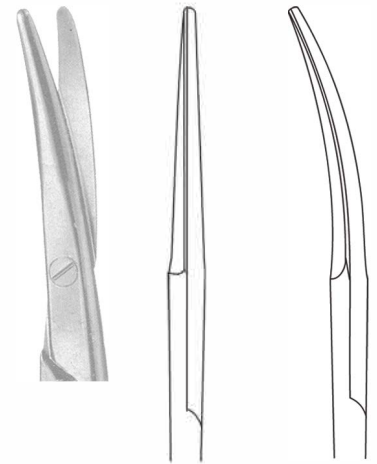

TABC 9300	STR	115 mm
TABC 9311	CVD	115 mm
TABC 6011	STR	140 mm
TABC 6055	CVD	140 mm
TABC 6800/1	STR	150 mm
TABC 6833/1	CVD	150 mm
TABC 6800	STR	160 mm
TABC 6833	CVD	160 mm
TABC 6022	STR	180 mm
TABC 6066	CVD	180 mm
TABC 6044	STR	200 mm
TABC 6077	CVD	200 mm



TABC 1666 CVD 130mm  
TABC 1688 CVD 150mm  
KILNER SCISSORS SPECIAL FLAT POINT  
for DISSECTING & UNDERMINING THE SKIN



EPISIOTOMY ( WALDMANN)  
SCISSORS

TAET 1422	180mm
TAET 1422/2	200mm
TAET 1422/1	240mm



TAET-1500  
SCHUHMACHER  
UMBILICAL CORD SCISSORS  
155 mm



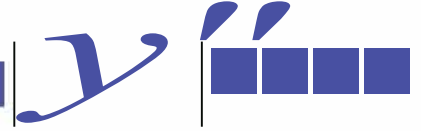

TABC 7744 160 mm  
TABC 7755 180 mm

DOYEN HEAVY SCISSORS  
STR



TABC 7722 160 mm  
TABC 7766 180 mm

DOYEN HEAVY SCISSORS  
CVD



TABC 5044 14CM STR  
TABC 5044/1 14CM CVD  
TABC 5066 16CM STR  
TABC 5066/1 16CM CVD

DRESSING / INCISION / SCISSORS  
WITH PROBE POINTED FLATE SHAPE



BRAUN-STADLER  
(EPISITOMY SCISSORS)



TAET-1400  
145 mm



TAET-1411  
200 mm



TAHF 5022  
SET OF 3 PCS  
NAIL SCISSORS 9CM  
NAIL FILE 9CM & HANGING CHAIN





WIRE CUTTING SCISSORS  
120 mm  
TADP-5511



TABC-8155  
130 mm  
TWO NOTCHES HEAVY  
SCISSORS



KELLY DELICATE SCISSORS

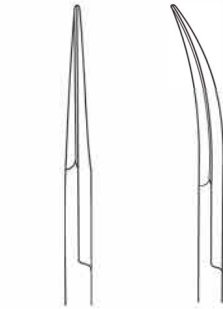

TABC-1600 TABC-1611 175 mm  
TABC 1600/1 TABC 1611/1 155mm



TABC5611-1  
MAYO HARRINGTON DISSECTING SCISSORS CVD  
180mm

TABC5611  
MAYO HARRINGTON DISSECTING SCISSORS CVD  
230mm

TABC5600-1  
MAYO HARRINGTON DISSECTING SCISSORS STR  
180mm

TABC5600  
MAYO HARRINGTON DISSECTING SCISSORS STR  
230mm



TAOM 7077/1 BOETTCHER SCISSORS  
18CM STR  
TAOM 7077 BOETTCHER SCISSORS  
18CM CVD

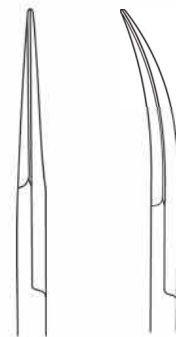

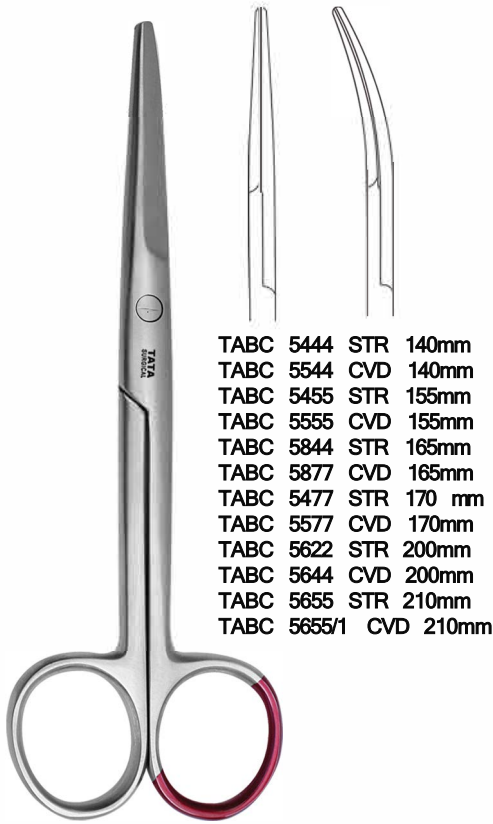

- TABC 5444 STR 140mm
- TABC 5544 CVD 140mm
- TABC 5455 STR 155mm
- TABC 5555 CVD 155mm
- TABC 5844 STR 165mm
- TABC 5877 CVD 165mm
- TABC 5477 STR 170 mm
- TABC 5577 CVD 170mm
- TABC 5622 STR 200mm
- TABC 5644 CVD 200mm
- TABC 5655 STR 210mm
- TABC 5655/1 CVD 210mm

MAYO-SCISSORS



TABC 1755

JAMESON / REYNOLDS  
SCISSORS CVD 130mm

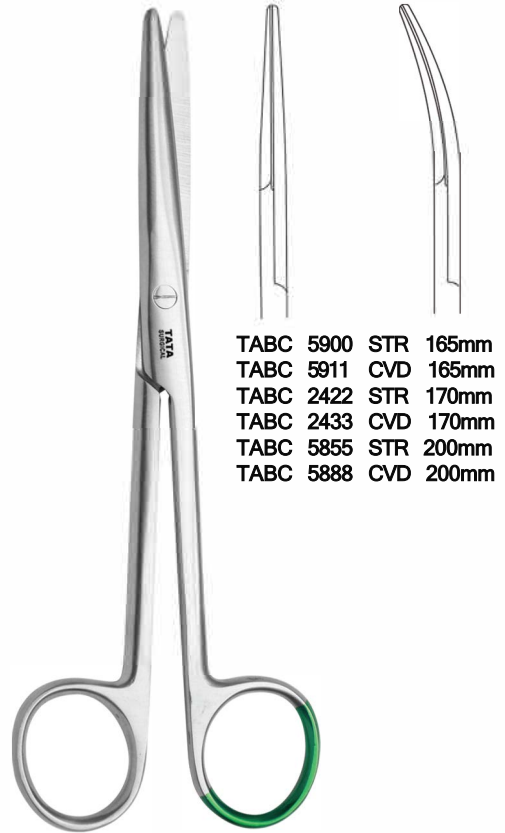

- TABC 5900 STR 165mm
- TABC 5911 CVD 165mm
- TABC 2422 STR 170mm
- TABC 2433 CVD 170mm
- TABC 5855 STR 200mm
- TABC 5888 CVD 200mm

MAYO-LEXER SCISSORS  
( STANDARD )

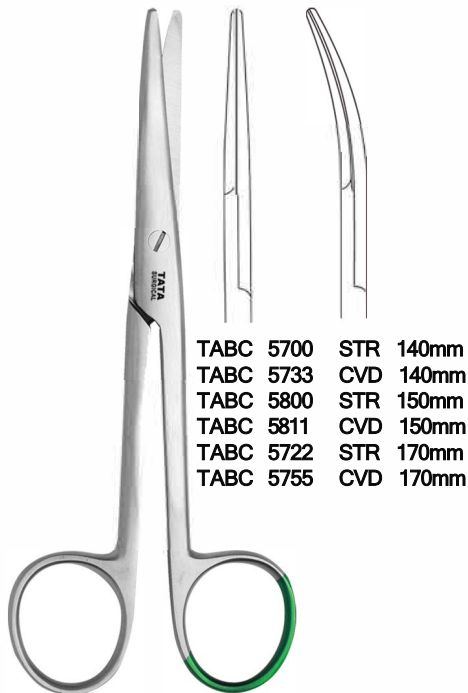

- TABC 5700 STR 140mm
- TABC 5733 CVD 140mm
- TABC 5800 STR 150mm
- TABC 5811 CVD 150mm
- TABC 5722 STR 170mm
- TABC 5755 CVD 170mm

MAYO-STILLE SCISSORS



TABC 3333  
UMBILICAL CORD SCISSORS SIDEWARDS  
200mm



TABC 2222  
FUNNY SCISSORS  
200mm

FLAT SHAPE SCISSORS

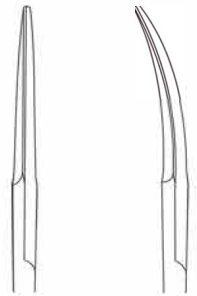

TABC 3411/FS	STR	115MM
TABC 4411/FS	CVD	115MM
TABC 3433/FS	STR	130MM
TABC 4433/FS	CVD	130MM
TABC 3444/FS	STR	140MM
TABC 4444/FS	CVD	140MM
TABC 3455/FS	STR	150MM
TABC 4455/FS	CVD	150MM
TABC 3466/FS	STR	160MM
TABC 4466/FS	CVD	160MM

SURGICAL SCISSORS SH/SH FLAT SHAPE

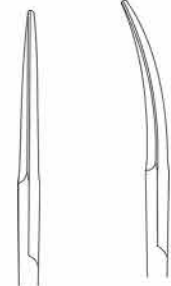

TABC 3200/FS	STR	105MM
TABC 4200/FS	CVD	105MM
TABC 3211/FS	STR	115MM
TABC 4211/FS	CVD	115MM
TABC 3211/1/FS	STR	120MM
TABC 4211/1/FS	CVD	120MM
TABC 3233/FS	STR	130MM
TABC 4233/FS	CVD	130MM
TABC 3244/FS	STR	140MM
TABC 4244/FS	CVD	140MM
TABC 3255/FS	STR	150MM
TABC 4255/FS	CVD	150MM
TABC 3266/FS	STR	160MM
TABC 4266/FS	CVD	160MM
TABC 3277/FS	STR	170MM
TABC 4277/FS	CVD	170MM
TABC 3288/FS	STR	185MM
TABC 4288/FS	CVD	185MM
TABC 3330/FS	STR	200MM

SURGICAL SCISSORS SH/BL FLAT SHAPE

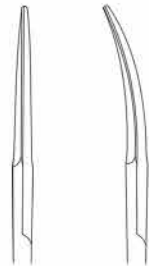

TABC 3122/FS	STR	115mm
TABC 4111/FS	CVD	115mm
TABC 3133/FS	STR	130mm
TABC 4133/FS	CVD	130mm
TABC 3144/FS	STR	140mm
TABC 4144/FS	CVD	140mm
TABC 3155/FS	STR	150mm
TABC 4155/FS	CVD	150mm
TABC 3166/FS	STR	160mm
TABC 4166/FS	CVD	160mm
TABC 3177/FS	STR	175mm
TABC 4177/FS	CVD	175mm
TABC 3188/FS	STR	180mm
TABC 4188/FS	CVD	180mm

SURGICAL SCISSORS BL/BL FLAT SHAPE

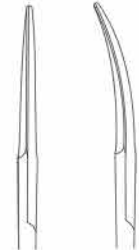

TABC 0566/FS	STR	90MM
TABC 0577/FS	CVD	90MM
TABC 0600/FS	STR	105MM
TABC 0611/FS	CVD	105MM
TABC 1100/FS	STR	110MM
TABC 1111/FS	CVD	110MM
TABC 1066/FS	STR	115MM
TABC 1077/FS	CVD	115MM
TABC 0644/FS	STR	120MM
TABC 0655/FS	CVD	120MM
TABC 1400/FS	STR	130MM
TABC 1411/FS	CVD	130MM

IRIS SCISSORS SH/SH FLAT SHAPE

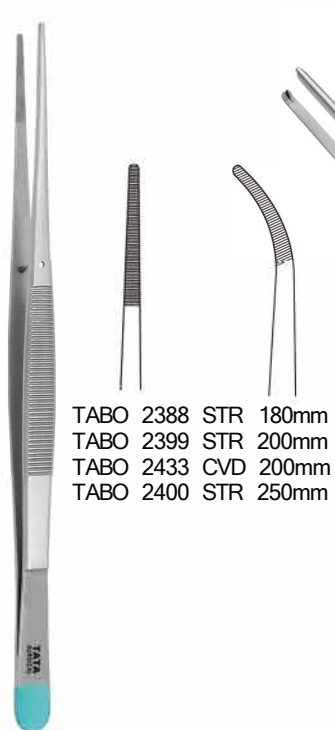
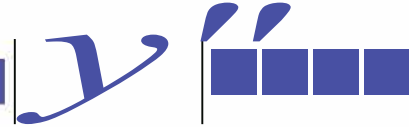

TABO 2388 STR 180mm  
 TABO 2399 STR 200mm  
 TABO 2433 CVD 200mm  
 TABO 2400 STR 250mm

CUSHING DISSECTING FORCEPS

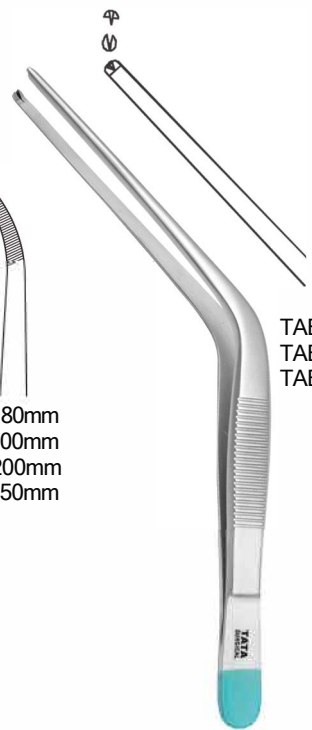

TABD 9033 115 mm  
 TABD 9122 140 mm  
 TABD 9133 170 mm

TROELTSCH TISSUE FORCEPS  
 1x2 Teeth

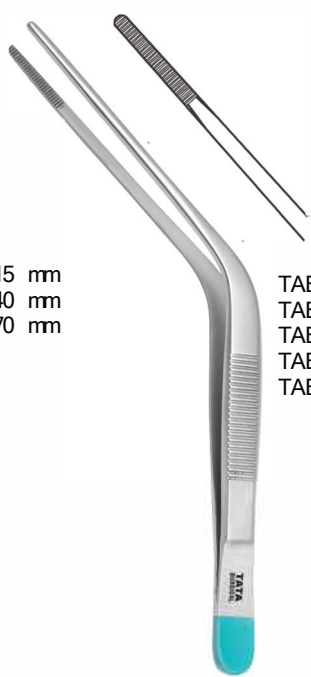

TABD 9000 100 mm  
 TABD 9022 115 mm  
 TABD 9100 140 mm  
 TABD 9111 170 mm  
 TABD 9100/1 150 mm

TROELTSCH FORCEPS



FEILCHENFELD  
 SPLINTER FORCEPS

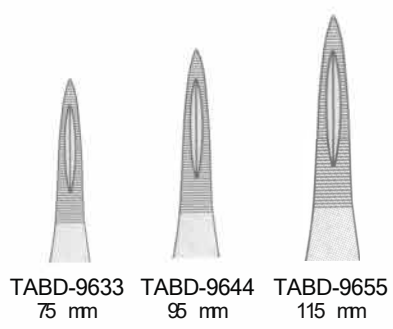

TABD-9633 75 mm  
 TABD-9644 95 mm  
 TABD-9655 115 mm

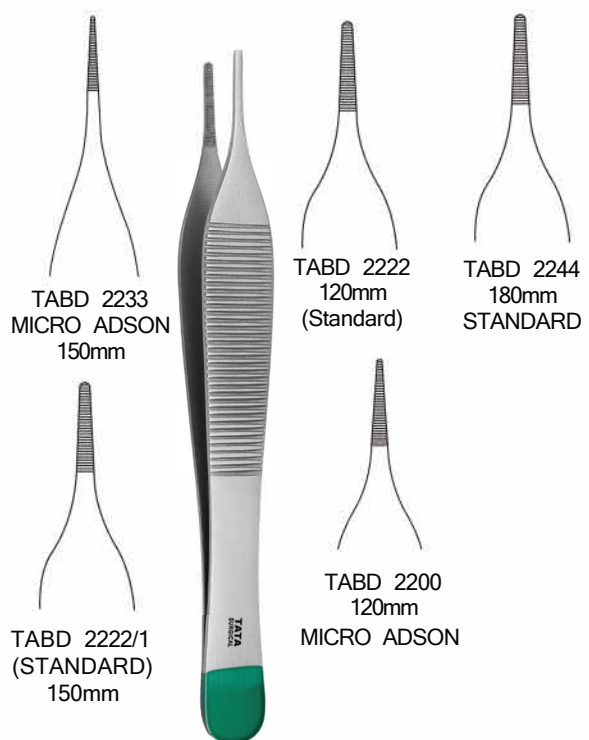

TABD 2233 MICRO ADSON 150mm  
 TABD 2222 120mm (Standard)  
 TABD 2244 180mm STANDARD  
 TABD 2222/1 (STANDARD) 150mm  
 TABD 2200 120mm MICRO ADSON

ADSON FORCEPS





- TABD 0433 115 mm
- TABD 0455 130 mm
- TABD 0477 145 mm
- TABD 0499 160 mm
- TABD 0500 180 mm
- TABD 0511 200 mm
- TABD 0522 250 mm
- TABD 0533 300 mm
- TABD 0544/1 350 mm
- TABD 0555/1 400 mm
- TABD 0566/1 450 mm
- TABD 0577/1 550 mm

DISSECTING FORCEPS  
STANDARD



- TABD 0233 115 mm
- TABD 0255 130 mm
- TABD 0277 145 mm
- TABD 0299 160 mm
- TABD 0300 180 mm
- TABD 0311 200 mm
- TABD 0322 250 mm
- TABD 0333 300 mm

DISSECTING FORCEPS  
MEDIUM



TAOC-0511  
85 mm

BISHOP-HARMON EYE FORCEPS  
1X2 TEETH



TADA 2433 150 mm  
LONDON-COLLEGE TWEEZER  
ANGLED, SERRATED

TADA 2711  
LONDON COLLEGE TWEEZERS  
SERRATED WITH LOCK 15CM



TADA 2211 160mm  
TOOTH TWEEZER  
ANGLED,ERRATED



MERIAM TWEEZER ANGLED,  
TADA 2122 SMOOTH 150mm  
TADA 2122/1 SERRATED 150mm  
TADA 2255 SERRATED 160mm  
TADA 2255/1 SMOOTH 150mm



TABD 2366  
MC INDOE DRESSING  
FORCEPS  
150mm



TABD 2366/1  
Mc INDOE DRESSING  
TISSUE FORCEPS  
150mm





TABD 8788  
JANSEN DISSECTING  
FORCEPS BAYONET SHAPED  
14CM



TABD 5277  
DISSECTING TISSUE FORCEPS  
1X2 TEETH CVD 14CM  
(MEDIUM)



TABD 0377  
DISSECTING FORCEPS MEDIUM  
CVD 14CM

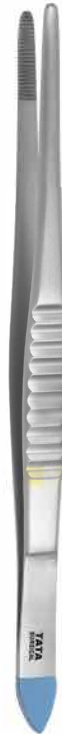

TABD 2133-1 150mm  
GILLIES / DISSECTING  
FORCEPS (STANDARD)



TOWEL CLUMP (JONES)  
TABF 4077 85mm  
TABF 4077/1 95mm

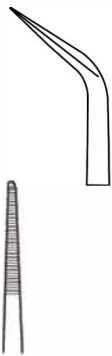

TABD 3022  
IRIS DISSECTING DELICATE  
FORCEPS  
STR 100 mm



TABD 3211  
ANGLED  
MICROSCOPY FORCEPS  
VERY FINE 100 mm



TABD 3211/1  
STR



TABD 3122  
IRIS DISSECTING DELICATE  
FORCEPS  
CVD 100 mm



TAOC 0255  
DELICATE TISSUE FORCEPS  
CVD 100 mm



DELICATE DISSECTING FORCEPS  
WITH OUT PIN  
TAB□ 3200 STR 100mm  
TAB□ 2100 STR 115mm  
TAB□ 2111 STR 130mm  
TAB□ 2122 STR 140mm



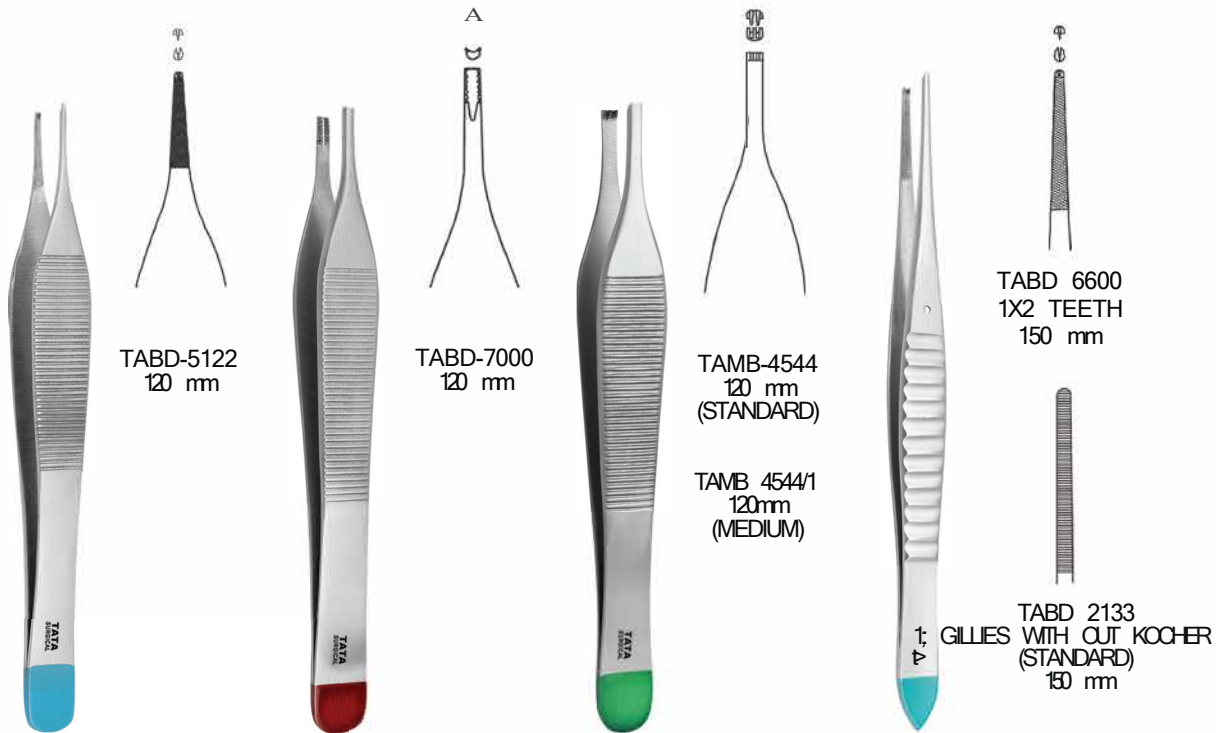

ADSON TISSUE FORCEPS  
1X2 Teeth with Plateau

ADSON BROWN  
Tissue Forceps ,Sharp

ADSON TISSUE  
FORCEPS  
2X3 Teeths

GILLIES TISSUE FORCEPS

TABD-5122  
120 mm

TABD-7000  
120 mm

TAMB-4544  
120 mm  
(STANDARD)

TAMB 4544/1  
120mm  
(MEDIUM)

TABD 6600  
1X2 TEETH  
150 mm

TABD 2133  
GILLIES WITH OUT KOCHER  
(STANDARD)  
150 mm

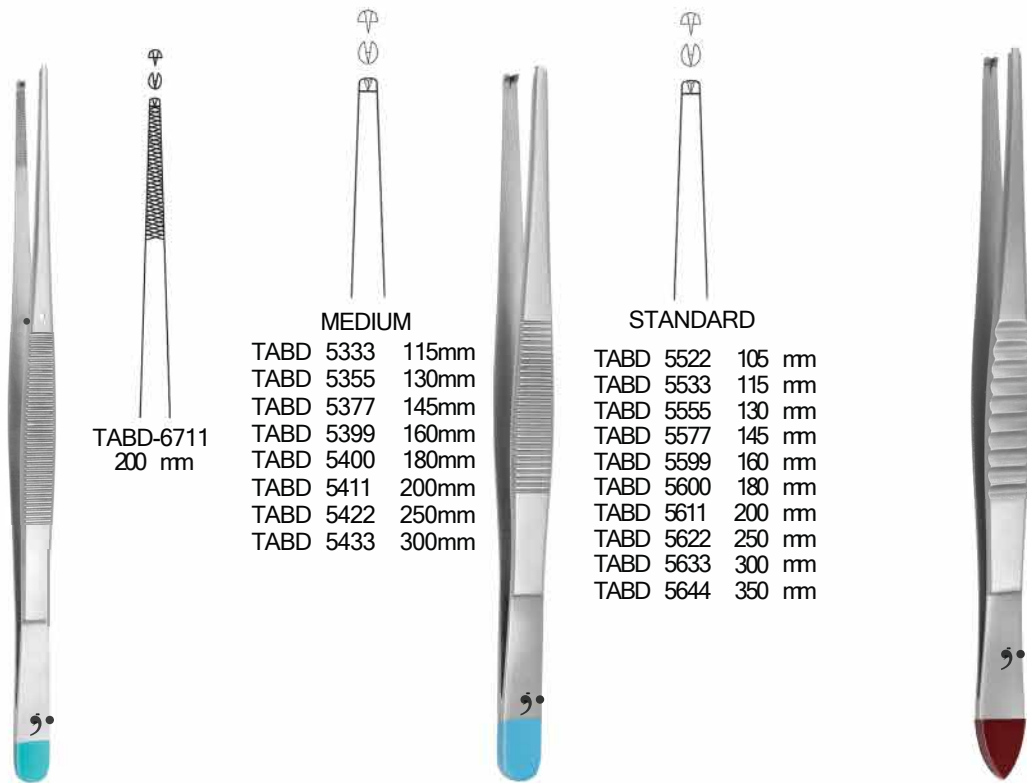

TISSUE FORCEPS  
(WAUGH)  
1X2 Teeth

TISSUE FORCEPS  
1X2 Teeth

TABD 6600-1  
GILLIES TISSUE FORCEPS  
STANDARD 1X2 TEETH  
150 mm

TABD-6711  
200 mm

MEDIUM

TABD 5333 115mm  
TABD 5355 130mm  
TABD 5377 145mm  
TABD 5399 160mm  
TABD 5400 180mm  
TABD 5411 200mm  
TABD 5422 250mm  
TABD 5433 300mm

STANDARD

TABD 5522 105 mm  
TABD 5533 115 mm  
TABD 5555 130 mm  
TABD 5577 145 mm  
TABD 5599 160 mm  
TABD 5600 180 mm  
TABD 5611 200 mm  
TABD 5622 250 mm  
TABD 5633 300 mm  
TABD 5644 350 mm



SEMKEN DELICATA TISSUE FORCEPS

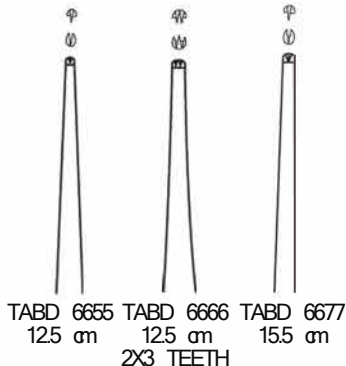

SEMKEN DELICATE DESSECTING FORCEPS

TABD 2155 125mm  
 TABD 2166 150mm



TABD 1212  
 T.O.E. DISSECTING FORCEPS  
 12.5CM

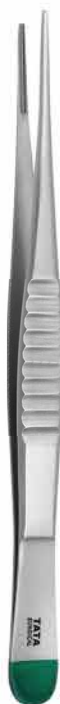

DeBAKEY ATRAUMATA DISSECTING FORCEPS

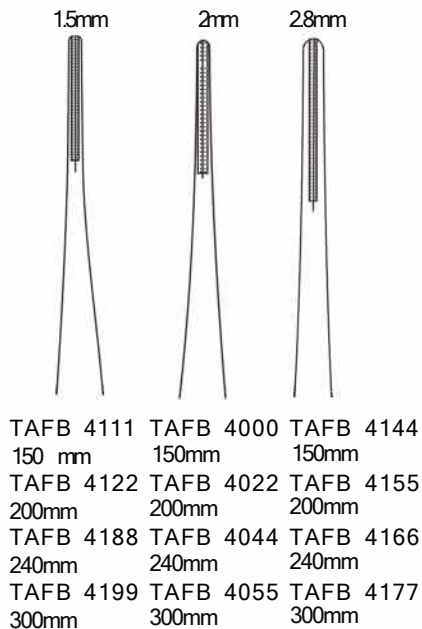

ADSON TISSUE FORCEPS  
 1x2 Teeth

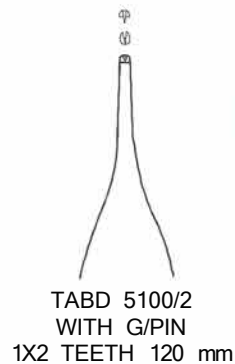
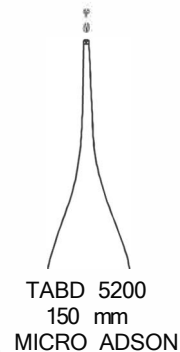

ADSON FORCEPS WITH G/PIN



TABD 8799  
LUCAE TISSUE FORCEPS  
BAYONET SHAPED  
1X2 TEETH 14CM



TABD 8800  
JANSEN DISSECTING FORCEPS  
BAYONET SHAPED  
16CM



TABD 8833  
GRUWALD DISSECTING FORCEPS  
BAYONET SHAPED  
16CM



TABD 9800/1  
HUNTER SPLINTER FORCEPS  
CVD 10.SCM



TABD 9800  
HUNTER SPLINTER  
FORCEPS STR 10.5CM



TABD 9988  
MOORFIELD EYE FORCEPS  
10CM



TABD 5011  
TISSUE FORCEPS VERY  
DELICATE  
1X2 TEETH 10CM STR



WILLIGER CURETTES  
170 mm

3.4mm  
0  
Fig. 00  
TAFK-6588  
5.2mm  
oy,  
Fig. 4  
TAFK-6599



TAFK-8500  
210 mm



BONE CURETTES  
DOUBLE ENDED

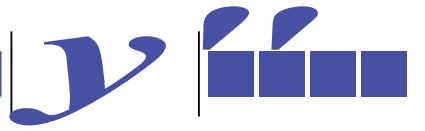

TABH 0266  
DIEFFENBACH BULLDOG CLAMP ,  
58MM STR, JAW LENGHT 16MM



TABH 0277  
DIEFFENBACH BULLDOG CLAMP ,  
58MM CVD, JAW LENGHT 16MM



TABH 0200  
DIEFFENBACH BULLDOG CLAMP ,  
38MM STR, JAW LENGHT 12MM



TABT 0122  
CRILE RETRACTOR DOUBLE-ENDED  
1x 4 MM 19 x 6 MM 11CM



TAFB 4244  
De BEKEY ATRAUMATA BULLDOG CLAMP  
105MM , STR, JAW LENGTH 50MM



TAFB 4255  
De BEKEY ATRAUMATA BULLDOG CLAMP  
97MM , CVD, JAW LENGTH 42MM



NASAL SPECULUM  
THUDICHUM ( MARK HOVELL)



TAOK 1611  
8.5 X 6.0, 70MM



TAOK 1622  
9.0 X 7.0, 71MM



TAOK 1633  
12.5 X 8.0, 72MM



TAOK 1644  
15.0 X 8.5, 73MM



TAOK 1655  
16.5 X 9.0, 74MM



TAOK 1666  
18.0 X 10.0, 74MM



TAOK 1677  
19.5 X 10.5, 75MM



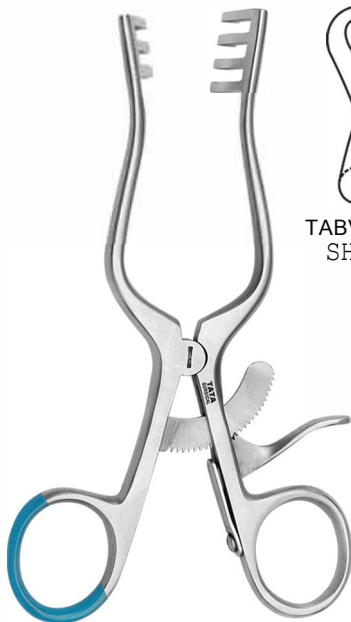

WEITLANER RETRACTORS  
130 mm



TABV-0711  
SHARP



TABV-0677  
SEMI SHARP



TABV 0744  
BLUNT



ROUX RETRACTORS  
SET OF 3 17CM

- 19 X 22 mm
- 23 X 30 mm
- TABT 0311
- 25 X 26 mm
- 28 X 38 mm
- TABT 0322
- 28 X 29 mm
- 33 X 45 mm
- TABT 0333



TABT 0411  
US ARMY RETRACTOR  
SET OF 2  
26x15MM,22x15MM,  
30x15MM,43x15MM 22CM



TABT 0288  
ROUX RETRACTOR  
28 X 24 mm  
43 X 24 mm  
17CM



TABT 0200 12CM  
FARABEUFR RETRACTOR  
DOUBLE ENDED,SET OF 2  
25x10MM 22x10MM  
28x12MM 32x12MM



TABT 0211 15CM  
FARABEUFR RETRACTOR  
DOUBLE-ENDED,SET OF 2  
23x16MM 20x16MM  
24x16MM 28x16MM



TABT 0377 SET OF 2  
LANE RETRACTOR 16.5CM  
16X33MM 12X32MM  
16X29MM 12X27MM

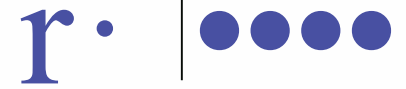

FOX DERMAL CURETTE 14CM (OVAL)  
TAFD 1200 2MM  
TAFD 1222 3MM  
TAFD 1233 4MM  
TAFD 1244 5MM  
TAFD 1255 6MM

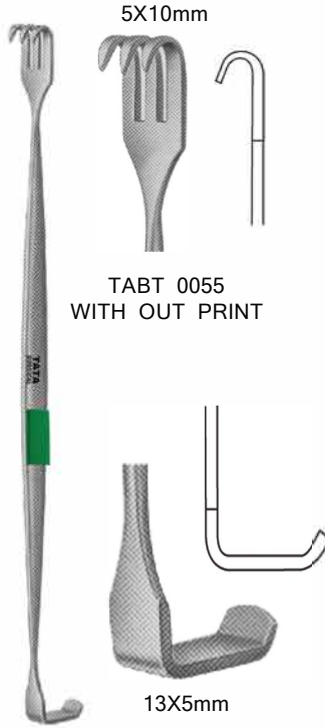

KILNER RETRACTOR  
DOUBLE ENDED  
155mm

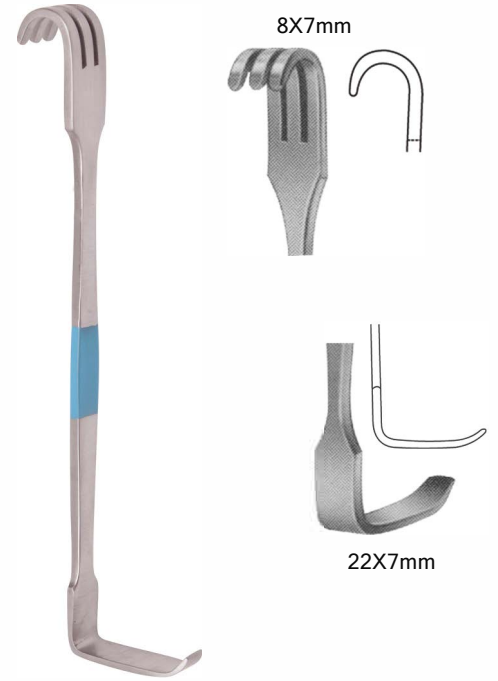

TABT 0077  
BABY-SENN-MILLER  
150 mm



DESMARRES LID  
RETRACTORS  
140 mm

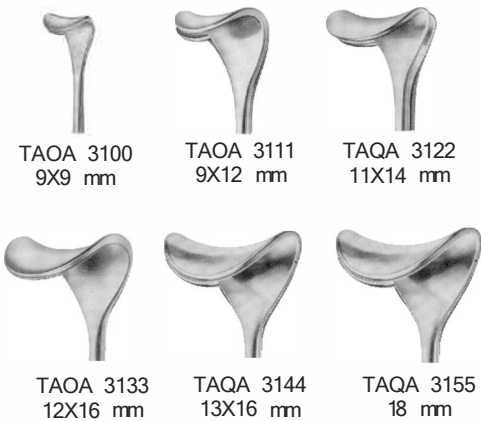

TAFK-8455  
BONE CURETTES  
Double Ended  
130 mm



TAFK-8466  
BONE CURETTES  
Double Ended  
160 mm

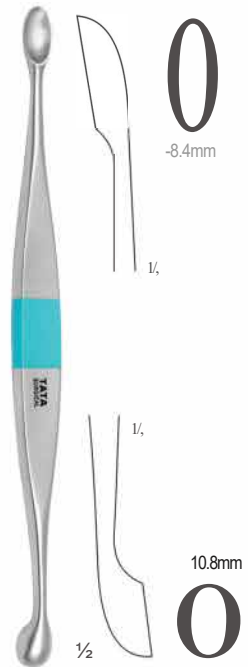

TAFK-8488  
BONE CURETTES  
Double Ended  
200 mm





TAOL6222 3MM



TAOL6233 6MM



TAOL6244 8MM

JOSEPH SKIN RETRACTOR  
16.5CM



TAOL 6211  
FREER SKIN RETRACTOR  
2 PRONGS 15CM



TABN 0044  
PROBE BUTTERFLY  
140mm



TABN 0155  
PROBE BUTTERFLY  
WITH TIP  
140mm



TABB 0844  
BP HANDLE  
No 4 135MM



TABB-0733  
BP HANDLE# 3  
SCALPEL HANDLE



TABB 0744  
BP HANDLE  
WITH SCALE  
No 3 125MM



TABB 0755  
BP HANDLE  
NO 3L LONG



TABB 0488  
SCALPEL HANDLE  
FOR MICRO-BLADES  
15.5CM





SCHEDI BONE CURETTE  
TAFK 6211 - TAFK 6277  
170mm

2.5mm 0 Fig.000 TAFK6211	3.4mm 0 Fig.00 TAFK6222	4.2mm 0 Fig.0 TAFK6233
-----------------------------------	----------------------------------	---------------------------------

5.2mm 0 Fig.1 TAFK6244	6.3mm 0 Fig.2 TAFK6255	7.4mm 0 Fig.3 TAFK6266	8mm 0 3/4 Fig.4 TAFK6277
---------------------------------	---------------------------------	---------------------------------	-----------------------------------

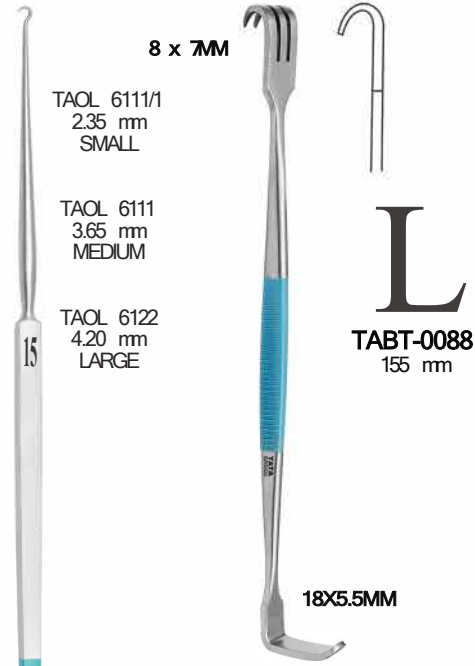

GILLIES SKIN HOOK  
RETRACTORS  
180 mm

8 x 7MM

TAOL 6111/1  
2.35 mm  
SMALL

TAOL 6111  
3.65 mm  
MEDIUM

TAOL 6122  
4.20 mm  
LARGE

**L**  
**TABT-0088**  
155 mm

18X5.5MM

SENN-MILLER RETRACTORS  
DOUBLE ENDED SHARP 8X7



TABN 757  
STAPLE REMOVER  
14mm

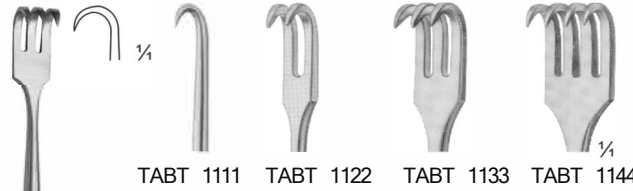

WOUND RETRACTORS SMALL CURVED ,SHARP  
5.0 X 4.2mm 5.0 x 7.0mm 5.0 x 9.5mm

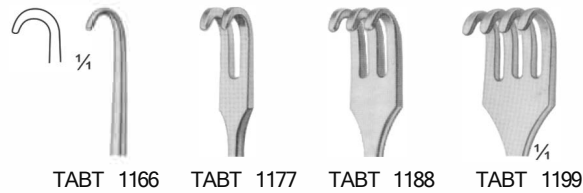

WOUND RETRACTORS SMALL CURVED ,BLUNT  
4.2 X 4.2mm 4.5 x 7.0mm 4.5 x 9.5mm

WOUND RETRACTORS  
165mm



1/2



VOLKMAN BONE CURETTES  
DOUBLE ENDED

ROUND



TABT 1322  
3.5 X 4.5 mm



TABT 1333  
4.0 X 7.2 mm



TABT 1344  
4.0 X 10.0 mm

SHARP



TABT 1366  
3.6 X 4.5 mm



TABT 1377  
4.0 X 7.5 mm



TABT 1388  
4.0 X 10.2mm



WOUND RETRACTOR  
FLEXIBLE SHAFT 160 mm



TAFK 8466/0 7MM  
TAFK 8466/1 6MM  
TAFK 8466/2 4MM  
TAFK 8466/3 2MM

BONE CURETTE  
SINGLE ENDED.SHARP  
14CM



TAPR 1011  
TW DILATATOR PROBE



TABT 0033  
BABY SENN MILLER  
8X7 22X7MM 10CM



TAEF 4011  
STRAUS PENIS CLAMP 130MM  
OPENING 4.5CM GAGE WIRE #15

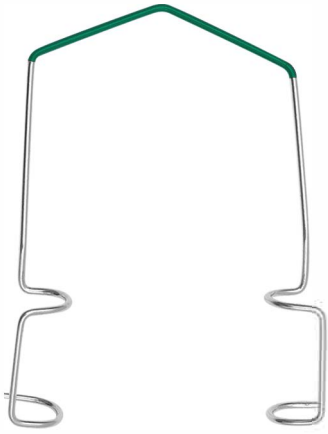
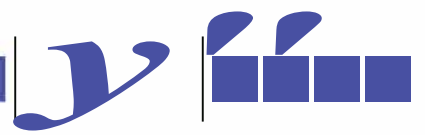

TAG 8011  
BARRAQUER EYE SPECULUM OPEN LOOP



TAG 8022  
KFRSHNER EYE SPECULUM



EYE EPECULA  
BARRAQUER  
TA 17-001 3CM  
TA 17-003 4CM

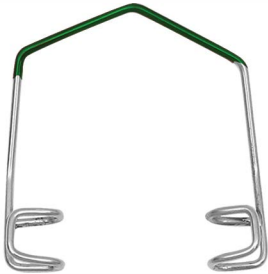

TAG 7788  
BABY EYE SPECULUM

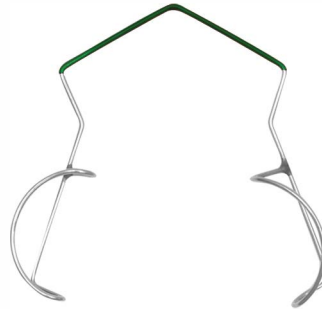

TAG 7799  
ADULT EYE SPECULUM

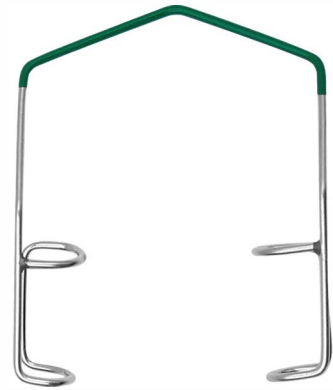

TAG 8000  
BARRAQUER EYE SPECULUM CLOSED LOOP



TAE0 0100  
SIMS UTERINE PROBE CURVED, GRADUATED, DIAMETER 4 MM 33CM



TAE0 0155  
SIMS UTERINE PROBE MALLEABLE, CURVED, GRADUATED, DIAMETER 3 MM 33CM





# SINGLE USE INSTRUMENTS



TADC 34015/1  
PROBES & EXPLORER  
# 23 ,15CM



TADA 4166  
TADC 34016/1  
PROBES & EXPLORER  
# 23 ,15CM



TAHF 5666  
NAIL FILE 150MM



TAKW 1766  
KIRSCHNER WIRE, ANGLED  
14.5CM



TAOF 2399  
WULLSTEIN SUCTION TUBE OD  
1.5MM 13CM



TAOH 1833  
OESCH MULLER HOOK SMALL



TAOH 1833/1L  
LEFT HAND



TAOH 1822  
OESCH MULLER HOOK MEDIUM



TAOH 1822/1L  
LEFT HAND



TAOH 1811  
OESCH MULLER HOOK LARGE



TAOH 1811/1L  
LEFT HAND



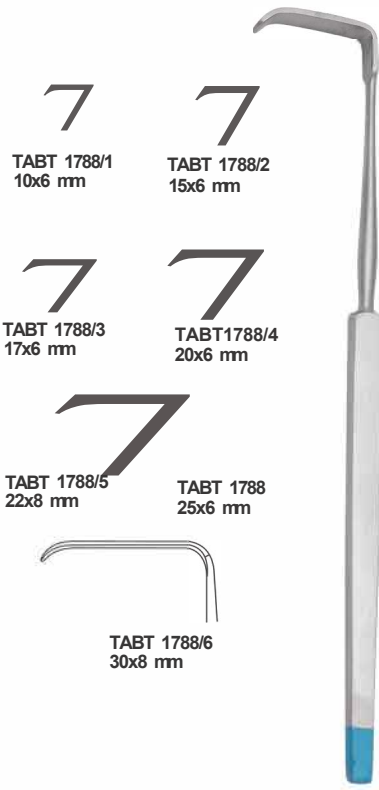
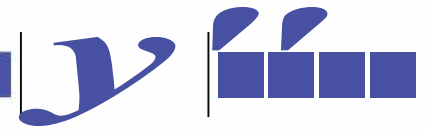

LANGENBECK RETRACTOR SENN GREEN  
PLAN HANDLE 16CM

TABT 1166  
WOUND HOOK SMALL CURVED, BLUNT  
16CM

TAOL 1655  
FREER RASPATORY  
ELEVATOR SHARP/ BLUNT  
18CM

- Q2.0mm TAOF 2822
- Q1.5mm TAOF 2833
- Q1.0mm TAOF 2844
- Q0.5mm TAOF 2855

- TAOF 2822/1 2.0mm
- TAOF 2833/1 1.5mm
- TAOF 2844/1 1.0mm
- TAOF 2855/1 0.5mm



TAOF 3600/1  
FORMBY CERUMEN SCOOP & HOOK  
18CM

WAGENER EAR HOOK,  
PROBE ENDED BALL  
15CM

WAGENER EAR HOOK,  
PROBE ENDED  
15CM

TAFK 8033/1  
JANSEN ROUND HANDLE ,  
EAR CURETTE, DOUBLE ENDED  
2.5mm , 3.4mm  
18CM

TAFK 8033/2  
JANSEN ROUND HANDLE ,  
EAR CURETTE, DOUBLE ENDED  
1mm , 2mm  
13CM





TAOL 1666  
NORDBERG ROGINE CUTTING INSTRUMENTS 17CM



TADB 7688  
PERIODONTOMETER (WILLIAMS) 15CM 3 3 2 3MM PCP 11



TADB 7688/1  
PERIODONTOMETERS, PCP 11,3 HOLLOW SINGLE HANDLE 15CM



TADC 0022 NORDBERG ROGINE 15CM



TADC 0011 INSTRUMENT FOR LIFTING TEMPORARY STOPPING 16.5CM



TADA 3100/1 PEIODENTAL PROBE 15CM



TADC 34017 EXPLORER SONDE 14.5CM



TASR 0007 STEEL RULLER 1DCM

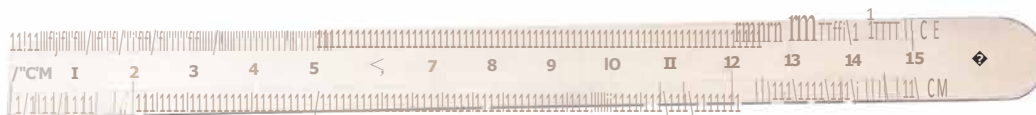

TASR 0008 STEEL RULLER 15CM



TADO 8011  
DESMOTOM STRAIGHT  
FILIGREE 16CM



TADO 8022  
DESMOTOM LEFT  
FILIGREE 17CM



TADO 8033  
DESMOTOM RIGHT  
FILIGREE 17CM



TAFB 1211  
VARADY PHLEBEXTRACTOR  
18CM



TABT 4044  
MIDDENDORPF  
CHEEK RETRACTOR  
15X15MM, 22CM



TABT 4055  
MIDDENDORPF  
CHEEK RETRACTOR  
20X22MM, 22CM



TABT 4066  
MIDDENDORPF  
CHEEK RETRACTOR  
28X28MM, 22CM



Tael 8800/1 SET  
GENTOFTE VAGINAL SPECULUM  
15X80MM , 32X100MM 21CM





CANNULA SUCTION NEEDLE  
120MM  
TACN 0014 1.9mm  
TACN 0014/0 1.0mm  
TACN 0014/1 1.2mm  
TACN 0014/2 2.0mm  
TACN 0014/3 2.2mm



CANNULA SUCTION NEEDLE  
100MM  
TACN 0011 1.9mm  
TACN 0011/0 1.0mm  
TACN 0011/1 2.0mm  
TACN 0011/2 2.2mm  
TACN 0011/3 1.2mm  
TACN 0011/4 1.6mm



CANNULA SUCTION NEEDLE  
80MM  
TACN 0012 0.8mm  
TACN 0012/1 1.2mm  
TACN 0012/2 2.0mm  
TACN 0012/3 1.0mm  
TACN 0012/4 1.9mm  
TACN 0012/5 2.0mm



CANNULA SUCTION NEEDLE  
60MM  
TACN 0013 1.0mm  
TACN 0013/1 1.2mm  
TACN 0013/2 1.4mm  
TACN 0013/3 1.9mm  
TACN 0013/4 2.0mm



TACN 0016  
GEBOGEN LUER LOCK CANNULA NEEDLE OD 2MM LENGTH  
73MM BANDED



TACN 2144  
WOLF INJECTION CANNULA NEEDLE WITH WIRE 35CM







TAGF 4311  
TEAR DROP SUCTION CANNULA TUBE RIGHT ANGLED TIP CURVED



TAGF 4322  
TEAR DROP SUCTION CANNULA TUBE LIFT ANGLED TIP CURVED

- CH- 8 2.7MM TABN 9022
- CH- 10 3.3MM TABN 9033
- CH- 12 4.0MM TABN 9044
- CH- 14 4.7MM TABN 9055
- CH- 16 5.3MM TABN 9066
- CH- 18 6.0MM TABN 9077

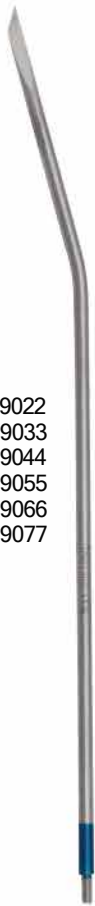

REDON GUIDE NEEDLE  
WITH THREAD KNIFE TIP,  
SLIGHTLY CURVED 190MM

- CH- 8 2.7MM TABN 9122
- CH- 10 3.3MM TABN 9133
- CH- 12 4.0MM TABN 9144
- CH- 14 4.7MM TABN 9155
- CH- 16 5.3MM TABN 9166
- CH- 18 6.0MM TABN 9177



REDON GUIDE NEEDLE  
WITH THREAD KNIFE TIP,  
STROGLY CURVED 190MM

- CH- 8 2.7MM TABN 9122/1
- CH- 10 3.3MM TABN 9133/1
- CH- 12 4.0MM TABN 9144/1
- CH- 14 4.7MM TABN 9155/1
- CH- 16 5.3MM TABN 9166/1
- CH- 18 6.0MM TABN 9177/1

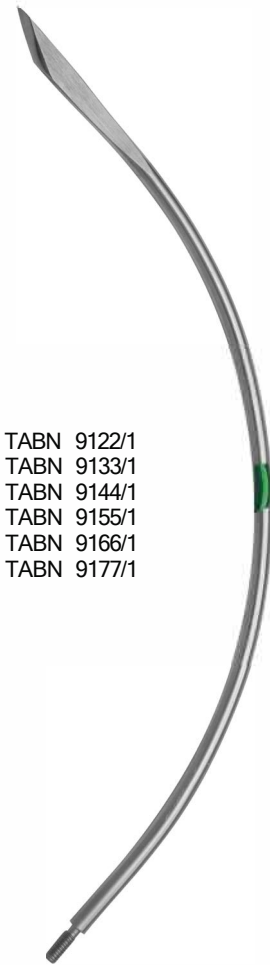

REDON GUIDE NEEDLE  
WITH THREAD KNIFE TIP,  
HIGHLY STROGLY CURVED 190MM





**BOWMANN LACRIMAL SINUS PROBE**  
 TAOB 5000 Dia 0.5 + 0.4MM Fig 0000/000  
 TAOB 5100 Dia 0.7 + 0.8MM Fig 00/0  
 TAOB 5111 Dia 0.9 + 1.1MM Fig 1/2  
 TAOB 5122 Dia 1.3 + 1.4MM Fig 3/4  
 TAOB 5133 Dia 1.5+ 1.6MM Fig 5/6  
 TAOB 5144 Dia 1.8+ 1.9MM Fig 7/8



**TAGF 1516  
 MAGILL SUCTION CANNULA**



**TAGF 8622  
 POOL SUCTION TUBE REGULAR HOLE**



**TAGF 8633  
 POOL SUCTION TUBE SMALL HOLE**



**TASR 0112 14CM  
 SUCTION CANNULA TUBE ( TROCARS)  
 DIA 1.5mm , 2.5mm , 3.0mm , 4.0mm , 6.0mm**

**TASR 0112/1 18CM  
 SUCTION CANNULA TUBE ( TROCARS)  
 DIA 1.5mm , 2.5mm , 3.0mm , 4.0mm , 6.0mm**



**TAGF 1515  
 SUCTION BUTTON CANNULA**



**SUCTION NEEDLE ONE SIDE HOLE WITH LUER LOCK**

- TAMC 1022 15MM O/D 1.2MM
- TAMC 1011 30MM O/D 1.2MM
- TAMC 1066 100MM O/D 1.2MM
- TAMC 1077 30MM O/D 2.0MM
- TAMC 1088 100MM O/D 2.0MM



**SUCTION NEEDLE HOLE TO HOLE 12MM DISTANCE WITH LUER LOCK**

- TAMC 1011 30MM O/D 1.2MM
- TAMC 1066 100MM O/D 1.2MM
- TAMC 1077 30MM O/D 2.0MM
- TAMC 1088 100MM O/D 2.0MM



TABN 4600 FARRELL COTTON APPLICATOR 1.2 MM DIAMETER, ROUND SERRATED END 14CM



FREER SEPTUM CHISEL  
TAOL 3111 STR  
TAOL 3144 CVD



TAOL 3188  
BALLENGER SEPTUM GOUGE, WITH NOTCH AND CUTTING EDGE 15CM



JOBSON-HORNE EAR PROBE  
TAOF 2666 14CM  
TAOF 2677 18CM



TASC 7788  
JAMISON SUCTION TUBE





TAND 1577  
PUNCTURE CANNULA NEEDLE 25CM 15G



TAND 1588  
PUNCTURE CANNULA NEEDLE 11G 12CM



TAND 1599  
PUNCTURE CANNULA NEEDLE 10G 12CM

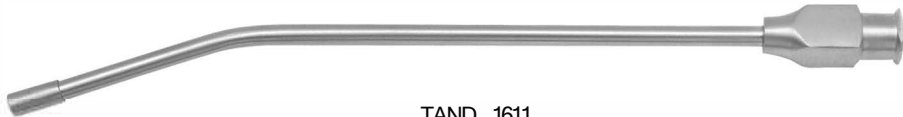

TAND 1611  
SUCTION WITH FINE BOTTON TIP 115mm



TAND 1533  
SUCTION **CANNULA** NEEDLE 1.4mm 70mm 17G

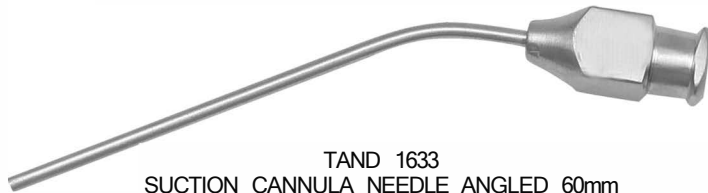

TAND 1633  
SUCTION CANNULA NEEDLE ANGLED 60mm



TAND 1522  
SUBTENNON ANESTHESIA SUCTION CANNULA 20G



TAND 1544  
PUNCTURE CANNULA NEEDLE 14G 11.5CM STR CUT DIA 2MM

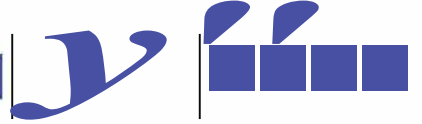

TAND 1555  
PUNCTURE CANNULA NEEDLE 30CM 11G



TAND 1566  
PUNCTURE CANNULA NEEDLE 11G 25CM



TAST 2211  
SUCTION TUBE 12.5 CM 90 DEGREE ANGLED OUTER DIA 0.4-2



TAND 1500  
SUCTION CANNULA NEEDLE 44.2mm WITH OLIVE BOTTON



TAND 1511  
SUCTION CANNULA NEEDLE 40mm



TAZS 1111  
ZOLLNER SUCTION TUBE LUER LOCK OD 2.5MM 13CM



TACN 2111 21G  
SUCTION CANNULE O-D 0.80 MM ROUND TIP WORKING LENGTH 60 MM



TACN 2122 25G  
SUCTION CANNULE O-D 0.64 MM ROUND TIP WORKING LENGTH 60 MM





TASP 1200  
THORAX SUCTION TUBE WITH TEAR DROP 37CM CVD



TASP 1300  
THORAX SUCTION TUBE WITH TEAR DROP 37CM CVD



TASP 1400  
THORAX SUCTION TUBE WITH TEAR DROP 37CM STR



TASP 1500  
THORAX SUCTION TUBE WITH TEAR DROP 37CM CVD



TASP 1600  
THORAX SUCTION TUBE WITH TEAR DROP 37CM STR



TAER 0111/2  
NOVAK CANNULA ENDOMETRIAL BIOPSY CURETTE WITH LUER LOCK WITH WIRE O/D 3MM 24CM

TAER 0111/3  
NOVAK CANNULA ENDOMETRIAL BIOPSY CURETTE WITH LUER LOCK WITH WIRE O/D 2MM 24CM



TASN 1122  
SUCTION CANNULA WITH LUER LOCK WORKING LENGTH 70MM ROUND TIP



TASN 1111  
SUCTION CANNULA WITH LUER LOCK WORKING LENGTH 71MM V / SHAPE TIP



TACP 1122  
STAINLESS STEEL CLAMP 5.5CM

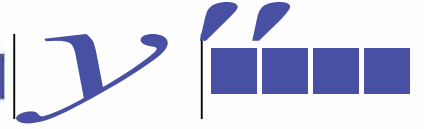

Trocar Tip Pencil Tip



TASP 1899  
STRINMANN PIN,TROCAR TIP,30CM 0/0 2 MM, STR

TASP 1899/1  
KIRSCHNER WIRE O/D 2.0MM POUND POINTED TIP LIKE PENCIL LENGTH 30CM

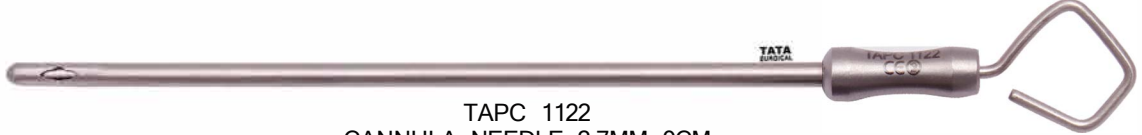

TAPC 1122  
CANNULA NEEDLE 2.7MM 9CM



TA 0018 3.1MM  
KONISCH LUER LOCK 38MM  
TA 0018/1 5.0MM  
KONISCH LUER LOCK 38MM



TACN 2020 47MM  
NEEDLE INSIDE DIA 0.9MM OUTER DIA 1.55MM



TASR 0001  
CANNULA CONNECTOR 51.5MM LONG



TASR 0002  
CANNULA CONNECTOR 51.0MM LONG



TASR 0003  
CANNULA CONNECTOR 60.8MM LONG



TASR 0004  
CANNULA CONNECTOR 53.1MM LONG



TAPC 1144 PINCTURE CANNULA NEEDLE CVD 2.5MM  
TAPC 1155 PUNCTURE CANNULA NEEDLE CVD 3.0MM



TACH 1010  
BAKALIT PROBE STAINLESS STEEL 60MM UPPER AREA 20CM





TAOK 0600  
NASAL SPECULUM SMALL SCREW JOINT



TAOM 2088  
TONGUE DEPRESSOR  
19CM



TABT 0044  
RAGNELL RETRACTOR DOUBLE-ENDED  
20X7MM, 12X5MM 15CM



TAHF 2344  
NAIL CUTTER 14CM



HARTMANN EAR SPECULA FOR ADULT  
AURAL , INSIDE NON-REFLECTIVE,  
OUTSIDE MIRROR FINISH

- TAOF 1344 O/D 1MM
- TAOF 1355 O/D 2MM
- TAOF 1366 O/D 3MM
- TAOF 1377 O/D 4MM
- TAOF 1377/1 O/D 4.5MM
- TAOF 1388 O/D 5MM
- TAOF 1388/1 O/D 5.5MM
- TAOF 1399 O/D 6MM
- TAOF 1400 O/D 7MM



HARTMANN EAR SPECULA FOR BABY  
AURAL , INSIDE NON-REFLECTIVE,  
OUTSIDE MIRROR FINISH

- TAOF 1155 O/D 1.8MM
- TAOF 1022 O/D 2MM
- TAOF 1033 O/D 3MM
- TAOF 1166 O/D 3.2MM
- TAOF 1044 O/D 4MM
- TAOF 1177 O/D 4.6MM







UNVIERSAL BANDAGE SCISSORS 18CM  
 TABC 9888 GREEN  
 TABC 8811 BLACK  
 TABC 9833 YELLOW



TACB 5533  
 CLEANING BRUSH



TACB 5522  
 CLEANING BRUSH



TACB 5511  
 CLEANING BRUSH



TABT 0100/1  
 LUER RETACTOR DOUBLE ENDED  
 10X8MM, 10X8MM  
 14CM



TAOM 4544 19X1 5MM  
 TAOM 4566 22X1 7MM  
 ADENOID CURETTE BECKMANN  
 20CM



TADL 0344/1 17CM  
 TADL 0344/2 30CM  
 FLAT HANDLE ROOT ELEVATOR  
 (BIEN) AROUND TIP





**PROBE DOUBLE ENDED**

DIA 1.0mm			DIA 1.5mm			DIA 2.0mm		
TABN 1122/1	11.5CM		TABN 1133/1	11.5CM		TABN 1144/1	11.5CM	
TABN 1122/2	13CM		TABN 1133/2	13CM		TABN 1144/2	13CM	
TABN 1122/3	14.5CM		TABN 1133/3	14.5CM		TABN 1144/3	14.5CM	
TABN 1122/4	16CM		TABN 1133/4	16CM		TABN 1144/4	16CM	
TABN 1122/5	18CM		TABN 1133/5	18CM		TABN 1144/5	18CM	
TABN 1122/6	20CM		TABN 1133/6	20CM		TABN 1144/6	20CM	
TABN 1122/7	25CM		TABN 1133n	25CM		TABN 1144n	25CM	



**PROBE WITH EYE**

DIA 1.0mm			DIA 1.5mm			DIA 2.0mm		
TABN 1211/1	11.5CM		TABN 1322/1	11.5CM		TABN 1433/1	11.5CM	
TABN 1211/2	13CM		TABN 1322/2	13CM		TABN 1433/2	13CM	
TABN 1211/3	14.5CM		TABN 1322/3	14.5CM		TABN 1433/3	14.5CM	
TABN 1211/4	16CM		TABN 1322/4	16CM		TABN 1433/4	16CM	
TABN 1211/5	18CM		TABN 1322/5	18CM		TABN 1433/5	18CM	
TABN 1211/6	20CM		TABN 1322/6	20CM		TABN 1433/6	20CM	
TABN 1211/7	25CM		TABN 1322n	25CM		TABN 1433n	25CM	



**PROBE WITH ARROW POINT**

DIA 1.0mm			DIA 1.5mm			DIA 2.0mm		
TABN 1544/1	11.5CM		TABN 1655/1	11.5CM		TABN 1766/1	11.5CM	
TABN 1544/2	13CM		TABN 1655/2	13CM		TABN 1766/2	13CM	
TABN 1544/3	14.5CM		TABN 1655/3	14.5CM		TABN 1766/3	14.5CM	
TABN 1544/4	16CM		TABN 1655/4	16CM		TABN 1766/4	16CM	
TABN 1544/5	18CM		TABN 1655/5	18CM		TABN 1766/5	18CM	
TABN 1544/6	20CM		TABN 1655/6	20CM		TABN 1766/6	20CM	
TABN 1544/7	25CM		TABN 1655n	25CM		TABN 1766n	25CM	



**ONE SIDE PROBE**

DIA 1.0mm			DIA 1.5mm			DIA 2.0mm		
TABN 1877/1	11.5CM		TABN 1988/1	11.5CM		TABN 2011/1	11.5CM	
TABN 1877/2	13CM		TABN 1988/2	13CM		TABN 2011/2	13CM	
TABN 1877/3	14.5CM		TABN 1988/3	14.5CM		TABN 2011/3	14.5CM	
TABN 1877/4	16CM		TABN 1988/4	16CM		TABN 2011/4	16CM	
TABN 1877/5	18CM		TABN 1988/5	18CM		TABN 2011/5	18CM	
TABN 1877/6	20CM		TABN 1988/6	20CM		TABN 12011/6	20CM	
TABN 1877/7	25CM		TABN 1988n	25CM		TABN 2011n	25CM	





TAOF 2377  
WULLSTEIN SUCTION TUBE OD 1.MM 13CM



TAOF 2388  
WULLSTEIN SUCTION TUBE OD 2.0MM 15CM



TAOF 2399  
WULLSTEIN SUCTION TUBE OD 1.0MM 13CM



TAOM 6711  
SPECIAL SUCTION TUBE WITH TEAR 30CM STR



TASP 1100  
SPECIAL SUCTION TUBE WITH TEAR DROP CVD 37CM



TABN 0633  
LEAF PROBE 2MM 13CM





TASP 1700  
YANKAUR SUCTION TUBE WITH TEAR DROP SPECIAL DESIGN 37CM



TAYT 10-203  
YANKAUR SUCTION TUBE FLAT HANDLE 26.5CM



TAYT 10-205  
YANKAUR SUCTION TUBE ROUND HANDLE 33CM



TAYT 10-206  
SENNING SUCTION TUBE ROUND HANDLE 31CM



TAYT 10-208  
YANKAUR SUCTION TUBE SAMI FLAT HANDLE 32.5CM



TAYT 10-209  
YANKAUR SUCTION TUBE NEW VERSION FLAT HANDLE 33CM  
( SPECIAL TUBE)



**TEAR DROP FRAZIER SUCTION CANNULA TUBE WITH OLIVE & BALL WIRE**

Sr. No.	Working Lenght Total Lenght Outer Diameter	S 110mm, 165mm,	M 125mm, 180mm,	L 150mm, 205mm,	LL 175mm, 230mm,	XXL 205mm, 260mm,
1	8 FR 0 2.7MM	TAGF 0066-8	TAGF 0222-8	TAGF 0388-8	TAGF 0544-8	TAGF 066-8
2	9 FR 0 3.0MM	TAGF 0077-9	TAGF 0233-9	TAGF 0399-9	TAGF 0555-9	TAGF 077-9
3	10 FR 0 3.3MM	TAGF 0088-10	TAGF 0244-10	TAGF 0400-10	TAGF 0566-10	TAGF 088-10
4	12FR 0 4.0MM	TAGF 0099-12	TAGF 0255-11	TAGF 0411-12	TAGF 0577-12	TAGF 099-12
5	13FR 0 4.3MM	TAGF 0100-13	TAGF 0266-13	TAGF 0422-13	TAGF 0588-13	TAGF 100-13
6	14 FR Q 4.7MM	TAGF 0111-14	TAGF 0277-14	TAGF 0433-14	TAGF 0599-13	TAGF 111-13
7	15 FR Q 5.0MM	TAGF0122-15	TAGF 0288-15	TAGF 0444-15	TAGF 0600-15	TAGF 122-15
8	16 FR Q 5.3MM	TAGF 0133-16	TAGF 0299-16	TAGF 0455-16	TAGF 0611-16	TAGF 133-16
9	17 FRO 5.7MM	TAGF 0144-17	TAGF 0300-17	TAGF 0466-17	TAGF 0622-17	TAGF 144-17
10	18 FRO 6.0MM	TAGF 0155-18	TAGF 0311-18	TAGF 0477-18	TAGF 0633-18	TAGF155-18
11	19 FRQ6.3MM	TAGF 0166-19	TAGF 0322-19	TAGF 0488-19	TAGF 0644-19	TAGF 166-19



**TEAR DROP FRAZIER SUCTION CANNULA TUBE WITH OLIVE & MAN DRAIN WIRE**

Sr. No.	Working Lenght Total Lenght Outer Diameter	S 110mm, 165mm,	M 125mm, 180mm,	L 150mm, 205mm,	LL 175mm, 230mm,	XXL 205mm, 260mm,
1	<b>3 FR</b> ° <b>1.0MM</b>	TAGF 0700-3	TAGF 0866-3	TAGF 1122-3	TAGF 1288-3	TAGF 700-3
2	<b>4 FR</b> ° <b>1.4MM</b>	TAGF 0711-4	TAGF 0877-4	TAGF 1133-4	TAGF 1299-4	TAGF 711-4
3	<b>5 FR</b> ° <b>1.7MM</b>	TAGF 0722-5	TAGF 0888-5	TAGF 1144-5	TAGF 1300-5	TAGF 722-5
4	<b>6 FR</b> ° <b>2.0MM</b>	TAGF 0733-6	TAGF 0899-6	TAGF 1155-6	TAGF 1311-6	TAGF 733-6
5	<b>7 FR</b> ° <b>2.3MM</b>	TAGF 0744-7	TAGF 0900-7	TAGF 1166-7	TAGF 1322-7	TAGF 744-7
6	<b>8 FR</b> ° <b>2.7MM</b>	TAGF 0755-8	TAGF 0911-8	TAGF 1177-8	TAGF 1333-8	TAGF 755-8
7	<b>9 FR</b> ° <b>3.0MM</b>	TAGF 0766-9	TAGF 0922-9	TAGF 1188-9	TAGF 1344-9	TAGF 766-9
8	<b>10 FR</b> ° <b>3.3MM</b>	TAGF 0777-10	TAGF 0933-10	TAGF 1199-10	TAGF 1355-10	TAGF 777-10
9	<b>12 FR</b> ° <b>4.0MM</b>	TAGF 0788-12	TAGF 0944-12	TAGF 1200-12	TAGF 1366-12	TAGF 788-12
10	<b>13 FR</b> ° <b>4.3MM</b>	TAGF 0799-13	TAGF 0955-13	TAGF 1211-13	TAGF 1377-13	TAGF 799-13
11	<b>14 FR</b> ° <b>4.7MM</b>	TAGF 0800-14	TAGF 0966-14	TAGF 1222-14	TAGF 1388-14	TAGF 800-14
12	<b>1s FR</b> ° <b>5.0MM</b>	TAGF 0811-15	TAGF 0977-15	TAGF 1233-15	TAGF 1399-15	TAGF 811-15
13	<b>16 FR</b> ° <b>5.3MM</b>	TAGF 0822-16	TAGF 0988-16	TAGF 1244-16	TAGF 1400-16	TAGF 822-16
14	<b>17 FR</b> ° <b>5.7MM</b>	TAGF 0833-17	TAGF 0999-17	TAGF 1255-17	TAGF 1411-17	TAGF 833-17
15	<b>18 FR</b> ° <b>6.0MM</b>	TAGF 0844-18	TAGF 1100-18	TAGF 1266-18	TAGF 1422-18	TAGF 844-18
16	<b>19 FR</b> ° <b>6.3MM</b>	TAGF 0855-19	TAGF 1111-19	TAGF 1277-19	TAGF 1433-19	TAGF 855-19





**TEAR DROP FRAZIER SUCTION CANNULA TUBE WITH BALL WIRE**

Sr. No.	Working Length Total Length Outer Diameter	S 110mm, 165mm,	M 125mm, 180mm,	L 150mm, 205mm,	LL 175mm, 230mm,	XXL 205mm, 260mm,
1	8 FR Ø 2.7MM	TAGF 1555-8	TAGF 1711-8	TAGF 1877-8	TAGF 2033-8	TAGF 001-8
2	9 FR Ø 3.0MM	TAGF 1566-9	TAGF 1722-9	TAGF 1888-9	TAGF 2044-9	TAGF 566-9
3	10 FR Ø 3.3MM	TAGF 1577-10	TAGF 1733-10	TAGF 1899-10	TAGF 2055-10	TAGF 577-10
4	12 FR Ø 4.0MM	TAGF 1588-12	TAGF 1744-11	TAGF 1900-12	TAGF 2066-12	TAGF 588-12
5	13FR Ø 4.3MM	TAGF 1599-13	TAGF 1755-13	TAGF 1911-13	TAGF 2077-13	TAGF 599-13
6	14 FR Q 4.7MM	TAGF 1600-14	TAGF 1766-14	TAGF 1922-14	TAGF 2088-13	TAGF 600-13
7	15 FR Q 5.0MM	TAGF 1611-15	TAGF 1777-15	TAGF 1933-15	TAGF 2099-15	TAGF 611-15
8	16 FR Q 5.3MM	TAGF 1622-16	TAGF 1788-16	TAGF 1944-16	TAGF 2100-16	TAGF 622-16
9	17 FRO 5.7MM	TAGF 1633-17	TAGF 1799-17	TAGF 1955-17	TAGF 2111-17	TAGF 633-17
10	18 FRO 6.0MM	TAGF 1644-18	TAGF 1800-18	TAGF 1966-18	TAGF 2122-18	TAGF 644-18
11	19 FRQ 6.3MM	TAGF 1655-19	TAGF 1811-19	TAGF 1977-19	TAGF 2133-19	TAGF 655-19



**TEAR DROP FRAZIER SUCTION CANNULA TUBE WITH MANDRAIN WIRE**

Sr. No.	Working Lenght Total Lenght Outer Diameter	S 110mm, 165mm,	M 125mm, 180mm,	L 150mm, 205mm,	LL 175mm, 230mm,	XXL 205mm, 260mm,
1	3 FR ° 1.0MM	TAGF 2200-3	TAGF 2366-3	TAGF 2522-3	TAGF 2688-3	TAGF 200-3
2	4FR ° 1.4MM	TAGF 2211-4	TAGF 2377-4	TAGF 2533-4	TAGF 2699-4	TAGF 211-4
3	5 FR ° 1.7MM	TAGF 2222-5	TAGF 2388-5	TAGF 2544-5	TAGF 2700-5	TAGF 222-5
4	6 FR ° 2.0MM	TAGF 2233-6	TAGF 2399-6	TAGF 2555-6	TAGF 2711-6	TAGF 233-6
5	7 FR ° 2.3MM	TAGF 2244-7	TAGF 2400-7	TAGF 2566-7	TAGF 2722-7	TAGF 244-7
6	8 FR ° 2.7MM	TAGF 2255-8	TAGF 2411-8	TAGF 2577-8	TAGF 2733-8	TAGF 255-8
7	9 FR ° 3.0MM	TAGF 2266-9	TAGF 2422-9	TAGF 2588-9	TAGF 2744-9	TAGF 266-9
8	10 FR ° 3.3MM	TAGF 2277-10	TAGF 2433-10	TAGF 2599-10	TAGF 2755-10	TAGF 277-10
9	12 FR ° 4.0MM	TAGF 2288-12	TAGF 2444-12	TAGF 2600-12	TAGF 2766-12	TAGF 288-12
10	13 FR ° 4.3MM	TAGF 2299-13	TAGF 2455-13	TAGF 2611-13	TAGF 2777-13	TAGF 299-13
11	14 FR ° 4.7MM	TAGF 2300-14	TAGF 2466-14	TAGF 2622-14	TAGF 2788-14	TAGF 300-14
12	15 FR ° 5.0MM	TAGF 2311-15	TAGF 2477-15	TAGF 2633-15	TAGF 2799-15	TAGF 311-15
13	16 FR ° 5.3MM	TAGF 2322-16	TAGF 2488-16	TAGF 2644-16	TAGF 2800-16	TAGF 322-16
14	17 FR ° 5.7MM	TAGF 2333-17	TAGF 2499-17	TAGF 2655-17	TAGF 2811-17	TAGF 333-17
15	18 FR ° 6.0MM	TAGF 2344-18	TAGF 2500-18	TAGF 2666-18	TAGF 2822-18	TAGF 344-18
16	19 FR ° 6.3MM	TAGF 2355-19	TAGF 2511-19	TAGF 2677-19	TAGF 2833-19	TAGF 355-19





### FRAZIER SUCTION CANNULA TUBE WITH MAN DRAIN WIRE

Sr. No.	Working Length Total Length Outer Diameter	S 110mm, 165mm,	M 125mm, 180mm,	L 150mm, 205mm,	LL 175mm, 230mm,	XXL 205mm, 260mm,
1	3 FR ◦ 1.0MM	TAGF 3700-3	TAGF 3866-3	TAGF 4022-3	TAGF 4188-3	TAGF 866-3
2	4FR ◦ 1.4MM	TAGF 3711-4	TAGF 3877-4	TAGF 4033-4	TAGF 4199-4	TAGF 877-4
3	5 FR ◦ 1.7MM	TAGF 3722-5	TAGF 3888-5	TAGF 4044-5	TAGF 4200-5	TAGF 888-5
4	6 FR ◦ 2.0MM	TAGF 3733-6	TAGF 3899-6	TAGF 4055-6	TAGF 4211-6	TAGF 899-6
5	7 FR ◦ 2.3MM	TAGF 3744-7	TAGF 3900-7	TAGF 4066-7	TAGF 4222-7	TAGF 900-7
6	8 FR ◦ 2.7MM	TAGF 3755-8	TAGF 3911-8	TAGF 4077-8	TAGF 4233-8	TAGF 911-8
7	9 FR ◦ 3.0MM	TAGF 3766-9	TAGF 3922-9	TAGF 4088-9	TAGF 4244-9	TAGF 922-9
8	10 FR ◦ 3.3MM	TAGF 3777-10	TAGF 3933-10	TAGF 4099-10	TAGF 4255-10	TAGF 933-10
9	12 FR ◦ 4.0MM	TAGF 3788-12	TAGF 3944-12	TAGF 4100-12	TAGF 4266-12	TAGF 944-12
10	13 FR ◦ 4.3MM	TAGF 3799-13	TAGF 3955-13	TAGF 4111-13	TAGF 4277-13	TAGF 955-13
11	14 FR ◦ 4.7MM	TAGF 3800-14	TAGF 3966-14	TAGF 4122-14	TAGF 4288-14	TAGF 966-14
12	1s FR ◦ 5.0MM	TAGF 3811-15	TAGF 3977-15	TAGF 4133-15	TAGF4299-15	TAGF 977-15
13	16 FR ◦ 5.3MM	TAGF 3822-16	TAGF 3988-16	TAGF 4144-16	TAGF 4300-16	TAGF 988-16
14	17 FR ◦ 5.7MM	TAGF 3833-17	TAGF 3999-17	TAGF 4155-17	TAGF 4311-17	TAGF 999-17
15	18 FR ◦ 6.0MM	TAGF 3844-18	TAGF 4000-18	TAGF 4166-18	TAGF 4322-18	TAGF 000-18
16	19 FR ◦ 6.3MM	TAGF 3855-19	TAGF 4011-19	TAGF 4177-19	TAGF 4333-19	TAGF 011-19



**FRAZIER SUCTION CANNULA TUBE WITH AN DRAIN BALL WIRE**

Sr. No.	Working Length Total Length Outer Diameter	S 110mm, 165mm,	M 125mm, 180mm,	L 150mm, 205mm,	LL 175mm, 230mm,	XXL 205mm, 260mm,
1	8 FR O 2.7MM	TAGF 4455-8	TAGF 4611-8	TAGF 4777-8	TAGF 4933-8	TAGF 455-8
2	9 FR O 3.0MM	TAGF 4466-9	TAGF 4622-9	TAGF 4788-9	TAGF 4944-9	TAGF 466-9
3	10 FR O 3.3MM	TAGF 4477-10	TAGF 4633-10	TAGF 4799-10	TAGF 4955-10	TAGF 477-10
4	12 FR O 4.0MM	TAGF 4488-12	TAGF 4644-11	TAGF 4800-12	TAGF 4966-12	TAGF 488-12
5	13FR O 4.3MM	TAGF 4499-13	TAGF 4655-13	TAGF 4811-13	TAGF 4977-13	TAGF 499-13
6	14 FR Q 4.7MM	TAGF 4500-14	TAGF 4666-14	TAGF 4822-14	TAGF 4988-14	TAGF 500-14
7	15 FR Q 5.0MM	TAGF 4511-15	TAGF 4677-15	TAGF 4833-15	TAGF 4999-15	TAGF 003-15
8	16 FR Q 5.3MM	TAGF 4522-16	TAGF 4688-16	TAGF 4844-16	TAGF 5000-16	TAGF 522-16
9	17 FRO 5.7MM	TAGF 4533-17	TAGF 4699-17	TAGF 4855-17	TAGF 5011-17	TAGF 533-17
10	18 FRO 6.0MM	TAGF 4544-18	TAGF 4700-18	TAGF 4866-18	TAGF 5022-18	TAGF 544-18
11	19 FRQ 6.3MM	TAGF 4555-19	TAGF 4711-19	TAGF 4877-19	TAGF 5033-19	TAGF 002-19



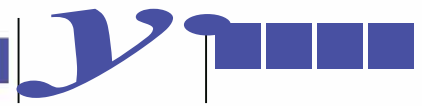

**FRAZIER SUCTION CANNULA TUBE WITH OLIVE & BALL WIRE**

Sr. No.	Working Lenght Total Lenght Outer Diameter	S 110mm, 165mm,	M 125mm, 180mm,	L 150mm, 205mm,	LL 175mm, 230mm,	XXL 205mm, 260mm,
1	8 FR O 2.7MM	TAGF 5099-8	TAGF 5255-8	TAGF 5422-8	TAGF 5588-8	TAGF 509-8
2	9 FR O 3.0MM	TAGF 5100-9	TAGF 5266-9	TAGF 5433-9	TAGF 5599-9	TAGF 510-9
3	10 FR O 3.3MM	TAGF 5511-10	TAGF 5277-10	TAGF 5444-10	TAGF 5600-10	TAGF 004-10
4	12 FR O 4.0MM	TAGF 5122-12	TAGF 5288-11	TAGF 5455-12	TAGF 5611-12	TAGF 512-12
5	13FR O 4.3MM	TAGF 5133-13	TAGF 5299-13	TAGF 5466-13	TAGF 5622-13	TAGF 513-13
6	14FR Q 4.7MM	TAGF 5144-14	TAGF 5300-14	TAGF 5477-14	TAGF 5633-14	TAGF 514-14
7	15 FR Q 5.0MM	TAGF 5155-15	TAGF 5311-15	TAGF 5488-15	TAGF 5644-15	TAGF 515-15
8	16 FR Q 5.3MM	TAGF 5166-16	TAGF 5322 -16	TAGF 5499-16	TAGF 5666-16	TAGF 516-16
9	17 FRO 5.7MM	TAGF 5177-17	TAGF 5333-17	TAGF 5500-17	TAGF 5677-17	TAGF 517-17
10	18 FRO 6.0MM	TAGF 5188-18	TAGF 5344-18	TAGF 5511-18	TAGF 5688-18	TAGF 518-18
11	19 FRQ6.3MM	TAGF 5199-19	TAGF 5355-19	TAGF 5522-19	TAGF 5699-19	TAGF 519-19



**FRAZIER SUCTION CANNULA TUBE WITH OLIVE & MANDRAIN WIRE**

Sr. No.	Working Length Total Length Outer Diameter	S 110mm, 165mm,	M 125mm, 180mm,	L 150mm, 205mm,	LL 175mm, 230mm,	XXL 205mm, 260mm,
1	<b>3 FR</b> ° <b>1.0MM</b>	TAGF 5700-3	TAGF 5866-3	TAGF 6022-3	TAGF 6188-3	TAGF 005-3
2	<b>4 FR</b> ° <b>1.4MM</b>	TAGF 5711-4	TAGF 5877-4	TAGF 6033-4	TAGF 6199-4	TAGF 006-4
3	<b>5 FR</b> ° <b>1.7MM</b>	TAGF 5722-5	TAGF 5888-5	TAGF 6044-5	TAGF 6200-5	TAGF 007-5
4	<b>6 FR</b> ° <b>2.0MM</b>	TAGF 5733-6	TAGF 5899-6	TAGF 6055-6	TAGF 6211-6	TAGF 008-6
5	<b>7 FR</b> ° <b>2.3MM</b>	TAGF 5744-7	TAGF 5900-7	TAGF 6066-7	TAGF 6222-7	TAGF 009-7
6	<b>8 FR</b> ° <b>2.7MM</b>	TAGF 5755-8	TAGF 5911-8	TAGF 6077-8	TAGF 6233-8	TAGF 010-8
7	<b>9 FR</b> ° <b>3.0MM</b>	TAGF 5766-9	TAGF 5922-9	TAGF 6088-9	TAGF 6244-9	TAGF 013-9
8	<b>10 FR</b> ° <b>3.3MM</b>	TAGF 5777-10	TAGF 5933-10	TAGF 6099-10	TAGF 6255-10	TAGF 014-10
9	<b>12 FR</b> ° <b>4.0MM</b>	TAGF 5788-12	TAGF 5944-12	TAGF 6100-12	TAGF 6266-12	TAGF 015-12
10	<b>13 FR</b> ° <b>4.3MM</b>	TAGF 5799-13	TAGF 5955-13	TAGF 6111-13	TAGF 6277-13	TAGF 016-13
11	<b>14 FR</b> ° <b>4.7MM</b>	TAGF 5800-14	TAGF 5966-14	TAGF 6122-14	TAGF 6288-14	TAGF 017-14
12	<b>15 FR</b> ° <b>5.0MM</b>	TAGF 5811-15	TAGF 5977-15	TAGF 6133-15	TAGF 6299-15	TAGF 018-15
13	<b>16 FR</b> ° <b>5.3MM</b>	TAGF 5822-16	TAGF 5988-16	TAGF 6144-16	TAGF 6300-16	TAGF 019-16
14	<b>17 FR</b> ° <b>5.7MM</b>	TAGF 5833-17	TAGF 5999-17	TAGF 6155-17	TAGF 6311-17	TAGF 020-17
15	<b>18 FR</b> ° <b>6.0MM</b>	TAGF 5844-18	TAGF 6000-18	TAGF 6166-18	TAGF 6322-18	TAGF 021-18
16	<b>19 FR</b> ° <b>6.3MM</b>	TAGF 5855-19	TAGF 6011-19	TAGF 6177-19	TAGF 6333-19	TAGF 022-19



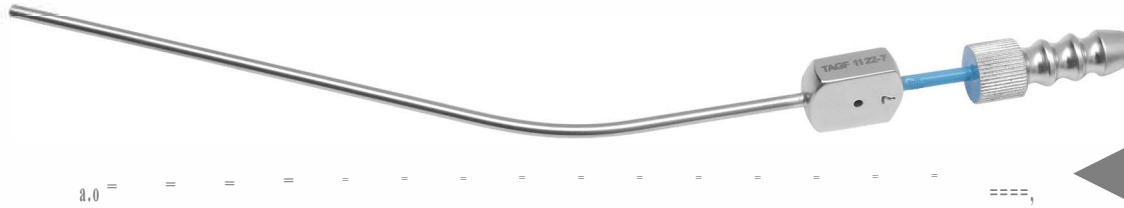

### FERGUSSON SUCTION CANNULA TUBE WITH BALL WIRE

Sr. No.	Working Lenght Total Lenght Outer Diameter	S 110mm, 165mm,	M 125mm, 180mm,	L 150mm, 205mm,	LL 175mm, 230mm,	XXL 205mm, 260mm,
1	8 FR O 2.7MM	TAGF 6655-8	TAGF 6811-8	TAGF 6977-8	TAGF 7133-8	TAGF 030-8
2	9 FR O 3.0MM	TAGF 6666-9	TAGF 6822-9	TAGF 6988-9	TAGF 7144-9	TAGF 031-9
3	10 FR O 3.3MM	TAGF 6677-10	TAGF 6833-10	TAGF 6999-10	TAGF 7155-10	TAGF 032-10
4	12FR O 4.0MM	TAGF 6688-12	TAGF 6844-11	TAGF 7000-12	TAGF 7166-12	TAGF 033-12
5	13FR O 4.3MM	TAGF 6699-13	TAGF 6855-13	TAGF 7011-13	TAGF 7177-13	TAGF 034-13
6	14FR Q 4.7MM	TAGF 6700-14	TAGF 6866-14	TAGF 7022-14	TAGF 7188-13	TAGF 035-13
7	15 FR Q 5.0MM	TAGF 6711-15	TAGF 6877-15	TAGF 7033-15	TAGF 7199-15	TAGF 036-15
8	16 FR Q 5.3MM	TAGF 6722-16	TAGF 6888-16	TAGF 7044-16	TAGF 7200-16	TAGF 037-16
9	17 FRO 5.7MM	TAGF 6733-17	TAGF 6899-17	TAGF 7055-17	TAGF 7211-17	TAGF 038-17
10	18 FRO 6.0MM	TAGF 6744-18	TAGF 6900-18	TAGF 7066-18	TAGF 7222-18	TAGF 039-18
11	19 FRQ 6.3MM	TAGF 6755-19	TAGF 6911-19	TAGF 7077-19	TAGF 7233-19	TAGF 040-19





**FERGUSSON SUCTION CANNULA TUBE WITH MANDRAIN WIRE**

Sr. No.	Working Length Total Length Outer Diameter	S 110mm, 165mm,	M 125mm, 180mm,	L 150mm, 205mm,	LL 175mm, 230mm,	XXL 205mm, 260mm,
1	<b>3 FR</b> ◦ <b>1.0MM</b>	TAGF 8000-3	TAGF 8166-3	TAGF 8322-3	TAGF 8488-3	TAGF 050-3
2	<b>4FR</b> ◦ <b>1.4MM</b>	TAGF 8011-4	TAGF 8177-4	TAGF 8333-4	TAGF 8499-4	TAGF 051-4
3	<b>5 FR</b> ◦ <b>1.7MM</b>	TAGF 8022-5	TAGF 8188-5	TAGF 8344-5	TAGF 8500-5	TAGF 052-5
4	<b>6 FR</b> ◦ <b>2.0MM</b>	TAGF 8033-6	TAGF 8199-6	TAGF 8355-6	TAGF 8511-6	TAGF 053-6
5	<b>7 FR</b> ◦ <b>2.3MM</b>	TAGF 8044-7	TAGF 8200-7	TAGF 8366-7	TAGF 8522-7	TAGF 054-7
6	<b>8 FR</b> ◦ <b>2.7MM</b>	TAGF 8055-8	TAGF 8211-8	TAGF 8377-8	TAGF 8533-8	TAGF 055-8
7	<b>9 FR</b> ◦ <b>3.0MM</b>	TAGF 8066-9	TAGF 8222-9	TAGF 8388-9	TAGF 8544-9	TAGF 056-9
8	<b>10 FR</b> ◦ <b>3.3MM</b>	TAGF 8077-10	TAGF 8233-10	TAGF 8399-10	TAGF 8555-10	TAGF 057-10
9	<b>12 FR</b> ◦ <b>4.0MM</b>	TAGF 8088-12	TAGF 8244-12	TAGF 8400-12	TAGF 8566-12	TAGF 058-12
10	<b>13 FR</b> ◦ <b>4.3MM</b>	TAGF 8099-13	TAGF 8255-13	TAGF 8411-13	TAGF 8577-13	TAGF 059-13
11	<b>14 FR</b> ◦ <b>4.7MM</b>	TAGF 8100-14	TAGF 8266-14	TAGF 8422-14	TAGF 8588-14	TAGF 060-14
12	<b>1s FR</b> ◦ <b>Os.oMM</b>	TAGF 8111-15	TAGF 8277-15	TAGF 8433-15	TAGF 8599-15	TAGF 061-15
13	<b>16 FR</b> ◦ <b>5.3MM</b>	TAGF 8122-16	TAGF 8288-16	TAGF 8444-16	TAGF 8600-16	TAGF 062-16
14	<b>17 FR</b> ◦ <b>5.7MM</b>	TAGF 8133-17	TAGF 8299-17	TAGF 8455-17	TAGF 8611-17	TAGF 063-17
15	<b>18 FR</b> ◦ <b>6.0MM</b>	TAGF 8144-18	TAGF 8300-18	TAGF 8466-18	TAGF 8622-18	TAGF 064-18
16	<b>19 FR</b> ◦ <b>6.3MM</b>	TAGF 8155-19	TAGF 8311-19	TAGF 8477-19	TAGF 8633-19	TAGF 065-19





**TEAR DROP SUCTION TUBE (F/DESIGN) WITH MANDRIN WIRE**

Sr. No.	Working Length Total Length Outer Diameter	S 165mm	M 180mm	L 205mm	LL 230mm	XL 260mm
1	3 FR o 1.0MM	TAGF 3000-3S	TAGF 3166-3M	TAGF 3322-3L	TAGF 3488-3LL	TAGF 3488-3XL
2	4 FR o 1.4MM	TAGF 3011-4S	TAGF 3177-4M	TAGF 3333-4L	TAGF 3499-4LL	TAGF 3499-4XL
3	SFR o 1.7MM	TAGF 3022-5S	TAGF 3188-5M	TAGF 3344-5L	TAGF 3500-5LL	TAGF 3500-5XL
4	6FR O 2.0MM	TAGF 3033-6S	TAGF 3199-6M	TAGF 3355-6L	TAGF 3511-6LL	TAGF 3511-6XL
5	7 FR O 2.3MM	TAGF 3044-7S	TAGF 3200-?M	TAGF 3366-?L	TAGF 3522-?LL	TAGF 3522-?XL
6	8 FR O 2.7MM	TAGF 3055-8S	TAGF 3211-BM	TAGF 3377-BL	TAGF 3533-BLL	TAGF 3533-BXL
7	9FR Q 3.0MM	TAGF 3066-9S	TAGF 3222-9M	TAGF 3388-9L	TAGF 3544-9LL	TAGF 3544-9XL
8	10FR Q 3.3MM	TAGF 3077-10S	TAGF 3233-10M	TAGF 3399-10L	TAGF 3555-10LL	TAGF 3555-10XL
9	12FR Q 4.0MM	TAGF 3088-12S	TAGF 3244-12M	TAGF 3400-12L	TAGF 3566-12LL	TAGF 3566-12XL

## RICHTER SUCTION TUBE (LIPOSUCTION)



TALS 5011

RICHTER SUCTION TUBE ,DIA 3.0MM WITH 3 SUCTION HOLE 20CM WORKING LENGTH



TALS 5022

RICHTER SUCTION TUBE ,DIA 3.0MM WITH 3 SUCTION HOLE 20CM WORKING LENGTH



TALS 5033

RICHTER SUCTION TUBE ,DIA 3.0MM WITH 3 SUCTION HOLE 30CM WORKING LENGTH





# RICHTER SUCTION TUBE (LIPOSUCTION)



TALS 5044

RICHTER SUCTION TUBE ,DIA 4.0MM WITH 3 SUCTION HOLE 20CM WORKING LENGTH



TALS 5055

RICHTER SUCTION TUBE ,DIA 4.0MM WITH 3 SUCTION HOLE 20CM WORKING LENGTH

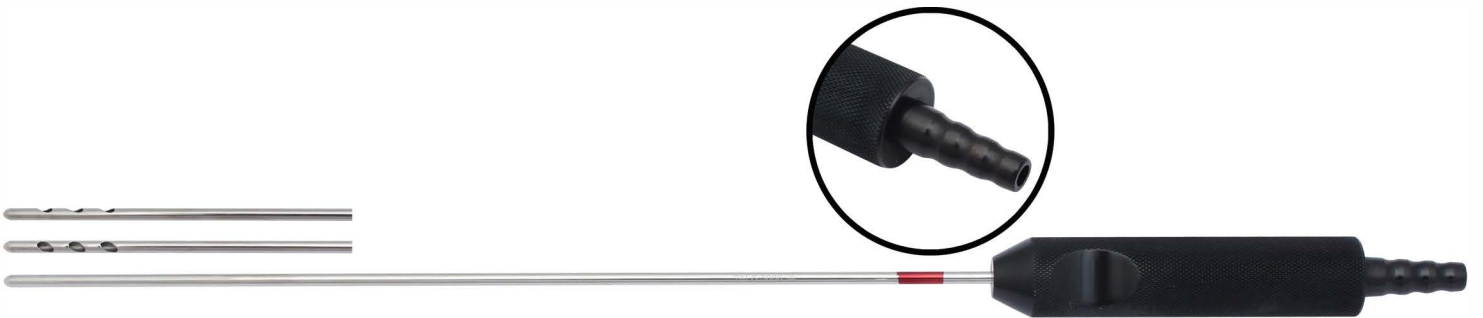

TALS 5066

RICHTER SUCTION TUBE ,DIA 4.0MM WITH 4 SUCTION HOLE 30CM WORKING LENGTH



## RICHTER SUCTION TUBE (LIPOSUCTION)

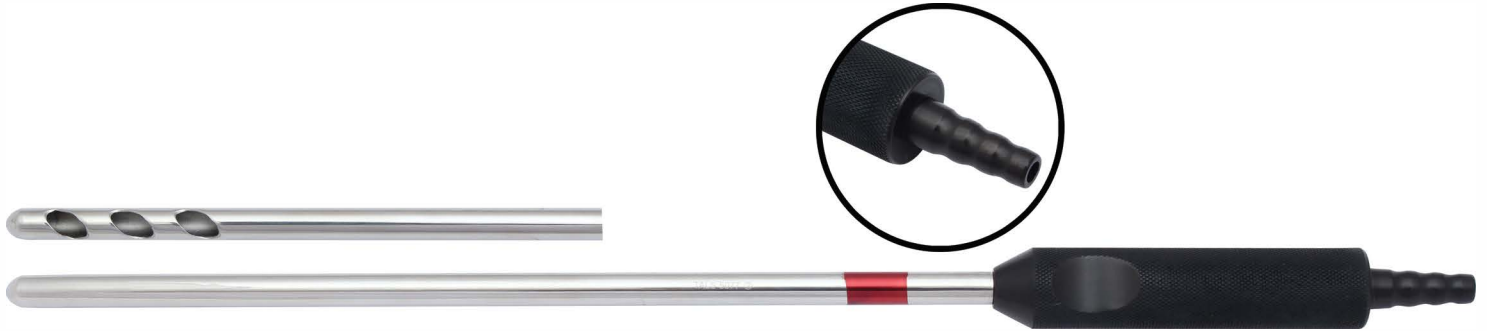

TALS 5077

RICHTER SUCTION TUBE ,DIA 10.0MM WITH 3 SUCTION HOLE 29.5CM WORKING LENGTH



TALS 5088

RICHTER SUCTION TUBE ,DIA 5.0MM WITH 3 SUCTION HOLE 30CM WORKING LENGTH



TALS 5099

RICHTER SUCTION TUBE ,DIA 4.0MM WITH 3 SUCTION HOLE 20CM WORKING LENGTH



## RICHTER SUCTION TUBE (LIPOSUCTION)

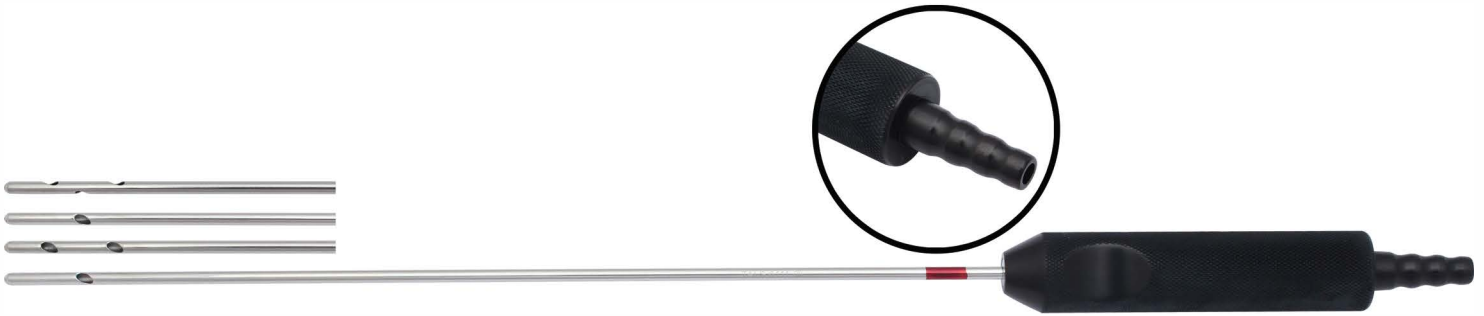

TALS6111

RICHTER SUCTION TUBE ,DIA 4.0MM WITH 3 SUCTION HOLE 30CM WORKING LENGTH



TALS6122

RICHTER SUCTION TUBE ,DIA 5.0MM WITH 3 SUCTION HOLE 20CM WORKING LENGTH

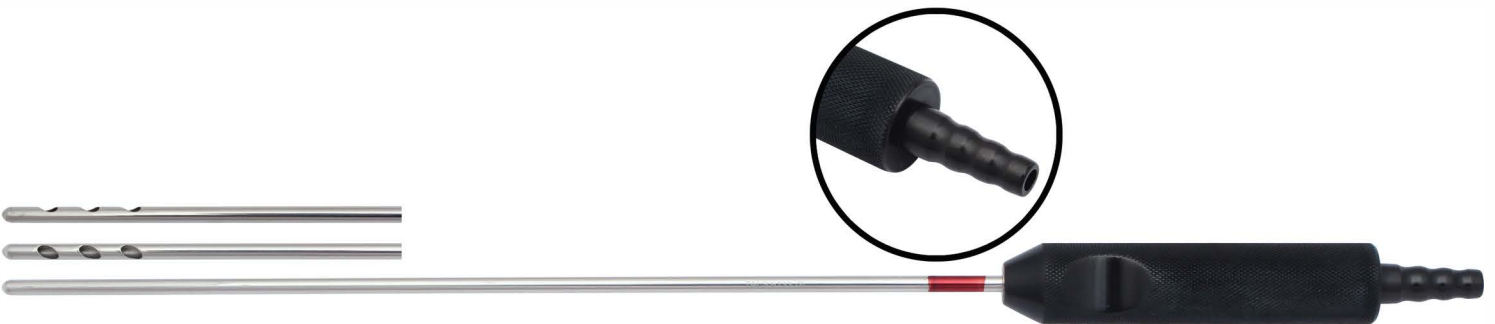

TALS6133

RICHTER SUCTION TUBE ,DIA 5.0MM WITH 3 SUCTION HOLE 30CM WORKING LENGTH





TAVF 4655/FG DIA 4.7MM  
TAVF 4666/FG DIA 3.0MM  
VASECTOMY RING FORCEPS  
14CM FULL GOLD



TAVF 4699/FG 12.5 CM CVD  
VESECTOMY FINE MOSQUITO FORCEPS  
FULL GOLD



TABF4311/FG 9CM  
TABF 4322/FG 11.5 CM  
BACKHAUS TOWEL CLAMP  
FULL GOLD

## VASECTOMY SET



TABF 4311/FG 9 CM  
2 PCS

TABF 4322/FG 11.5 CM  
1 PCS

TAVF 4655/FG DIA 3.0MM  
1 PCS

TAVF 4666/FG DIA 4.7MM  
1 PCS

TAVF 4699/FG 12.5 CM CVD  
2 PCS



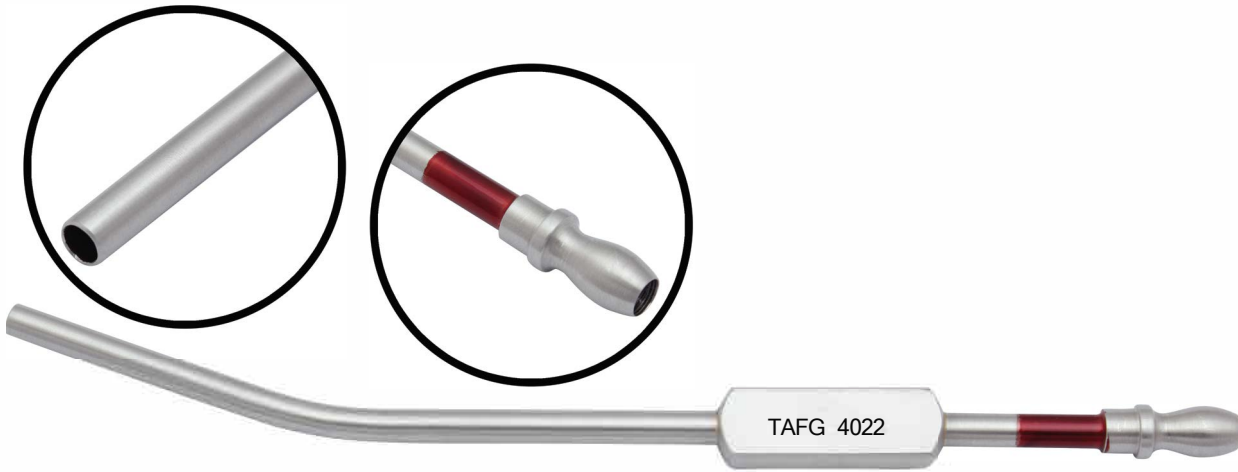

TAFG 4022  
ORL SUCTION TUBE DIA 5.0MM ANGLED 18 CM

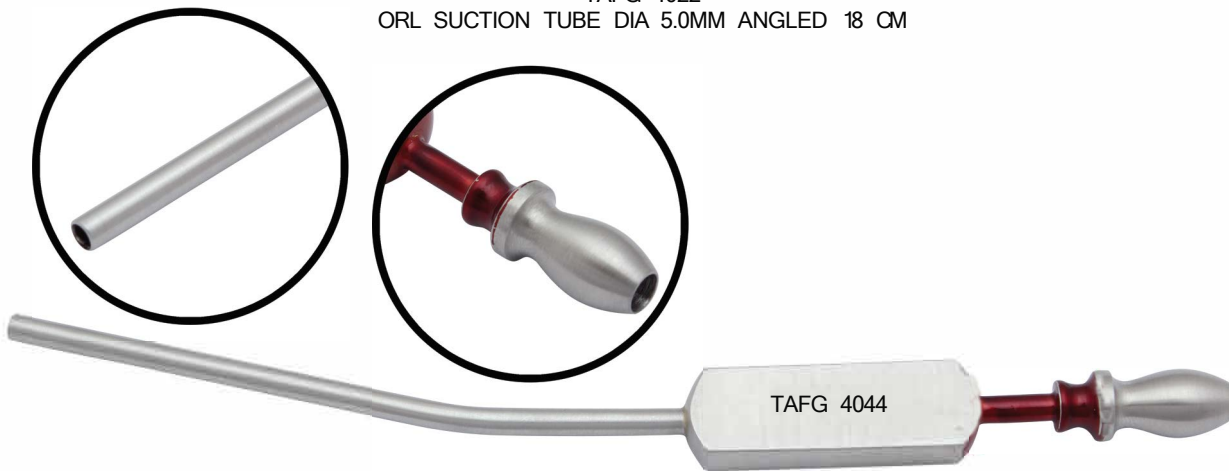

TAFG 4044  
ORL SUCTION TUBE DIA 3.0MM ANGLED 17CM

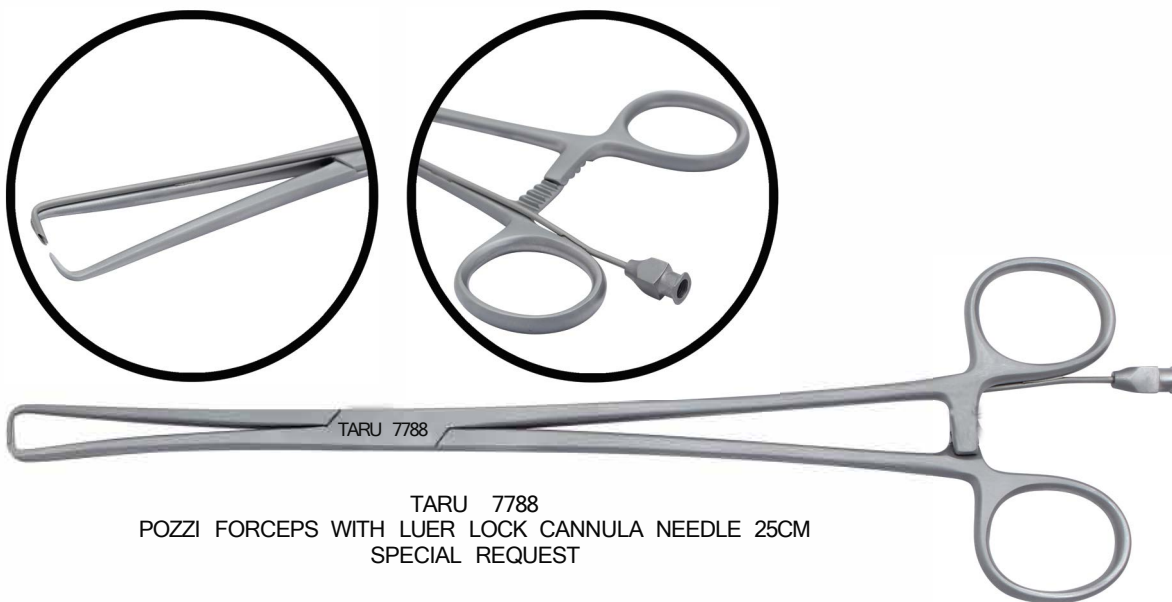

TARU 7788  
POZZI FORCEPS WITH LUER LOCK CANNULA NEEDLE 25CM  
SPECIAL REQUEST



TAOM0788  
TAAC4688  
FIG00  
06MM



TAOM0799  
TAAC4699  
FIG00  
0 8MM



TAOM0800  
TAAC4700  
FIG0  
010MM



TAOM 0811  
TAAC4711  
FIG 1  
012MM



TAOM0822  
TAAC4722  
FIG2  
014MM



TAOM0833  
TAAC4733  
FIG3  
016MM



TAOM0844  
TAAC4744  
FIG4  
018MM

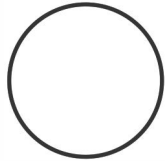

TAOM0855  
TAAC4755  
FIG5  
020MM

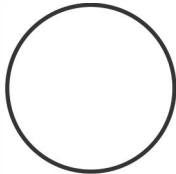

TAOM0866  
TAAC4766  
FIG6  
022MM

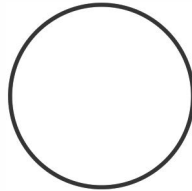

TAOM0877  
TAAC4m  
FIG7  
024MM

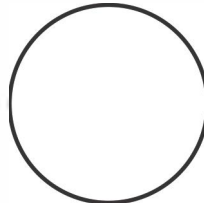

TAOM0888  
TAAC4788  
FIGS  
g26MM

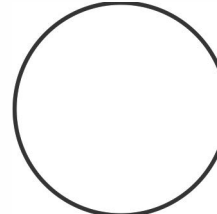

TAOM0899  
TAAC4799  
FIG9  
028MM

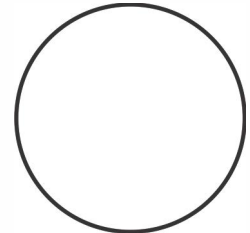

TAOM0900  
TAAC4800  
FIG 10  
030MM

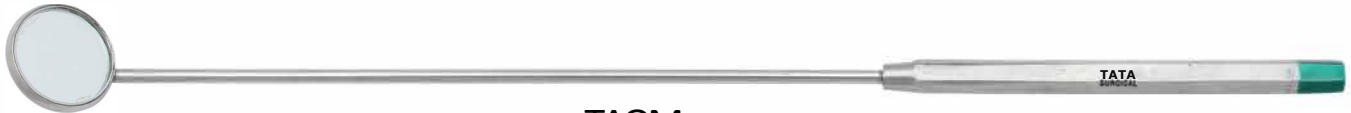

TAOM  
LARYNGEAL MIRROR with HEXAGONAL HANDLE 18CM



TAAC  
LARYNGEAL MIRROR



TADA 0744/1  
DENTAL MIRROR WITH HANDLE FIX MIRROR 19CM



TADA 0744/2  
DENTAL MIRROR WITH ADJUSTABLE HANDLE 16CM



# UTERINE DILATORS



- TAEM 2322 3 + 4 MM
- TAEM 2333 5 + 6 MM
- TAEM 2344 7 + 8 MM
- TAEM 2355 9 + 10 MM
- TAEM 2366 11 + 12 MM
- TAEM 2377 13 + 14 MM
- TAEM 2388 15 + 16 MM
- TAEM 2399 17 + 18 MM

TAEM 2322 - TAEM 2399  
HEGAR  
UTERINE DILATOR



TAEM 2444  
HEGAR  
UTERINE DILATOR SET





VAGINAL SPECULA  
LOWER BLADER



Tael 4444  
110 X 18MM  
215MM



Tael 4455  
110 X 20MM  
215MM



Tael 4466  
110 X 27MM  
220MM



Tael 4477  
110 X 30MM  
220MM



Tael 4488  
110 X 36MM  
225MM

KRISTELLER  
LOWER BLADES





VAGINAL SPECULA  
LOWER BLADES



KRISTELLER  
LOWER BLADES



Tael 4400  
70 X 15 MM  
175 MM



Tael 4411  
70 X 27 MM  
180 MM



Tael 4422  
75 X 30 MM  
180 MM



Tael 4433  
90 X 36 MM  
185 MM



VAGINAL SPECULA - UPPER BLADES



T A E L 4 5 4 4 1 1 5 X 1 4 M M  
2 1 5 M M



T A E L 4 5 5 5 1 1 5 X 1 6 M M  
2 1 5 M M



T A E L 4 5 6 6 1 1 5 X 2 3 M M  
2 2 0 M M



T A E L 4 5 7 7 1 1 5 X 2 6 M M  
2 2 0 M M



T A E L 4 5 8 8 1 2 0 X 3 0 M M  
2 2 5 M M



KRISTELLER  
UPPER BLADES





VAGINAL SPECULA - UPPER BLADES



KRISTELLER  
UPPER BLADES



Tael 4500 75 X 10 MM  
175 MM



Tael 4511 75X23MM  
180 MM



Tael 4522 80 X 25 MM  
180 MM



Tael 4533 100 X 32 MM  
185 MM





VAGINAL SPECULA -SET, UPPER & LOWER BLADES



KRISTELLER  
170 MM  
TAE 4200 70 X 15MM



KRISTELLER  
175 MM  
TAE 4211 70 X 27 MM  
TAE 4222 75 X 30 MM  
TAE 4233 90 X 36 MM



SEIDEL 170 MM  
TAE 4100 80 X 8 MM  
TAE 4111 80 X 10 MM  
TAE 4133 90 X 14 MM

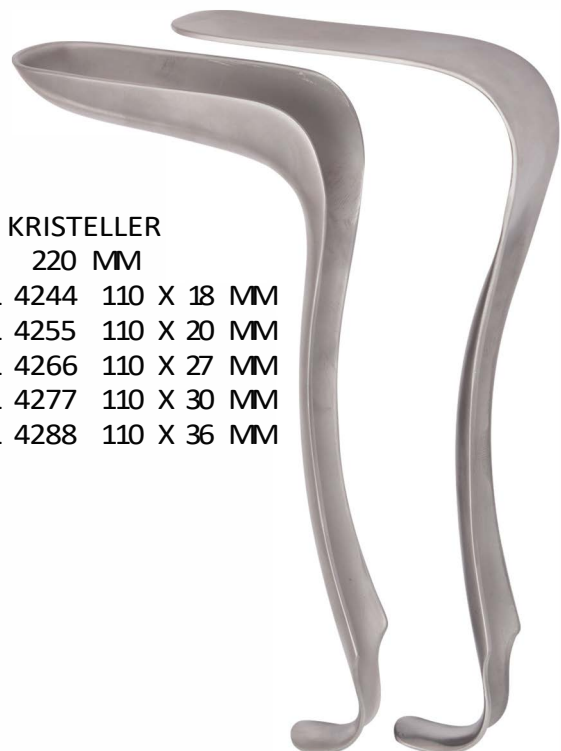

KRISTELLER  
220 MM  
TAE 4244 110 X 18 MM  
TAE 4255 110 X 20 MM  
TAE 4266 110 X 27 MM  
TAE 4277 110 X 30 MM  
TAE 4288 110 X 36 MM





**COMPOSITE SET OF 6 GOLD TITANIUM COATING**



**A**



**B**



**C**



**D**



**E**



**F**



OMPOSITE SET OF 7 FILLING INSTRUMENTS TITANIUM GOLD COATING



AA



BB



CC



DD



EE



FF



GG



**DENTAL GRACEY CURETTES PERIODONTAL HOLLOW HANDLE DOUBLE ENDED  
FULL TITANIUM BLUE COATING 7 PCS SET**



TATA

AAA



TATA

BBB



TATA

CCC



TATA

DDD



TATA

EEE



TATA

FFF



TATA

GGG



**DENTAL GRACEY CURETTES PERIODONTAL HOLLOW HANDLE DOUBLE ENDED  
HALF TITANIUM BLUE COATING 7 PCS SET**

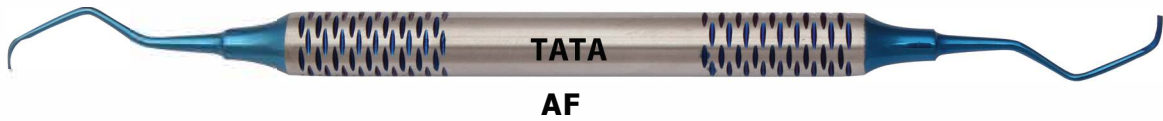



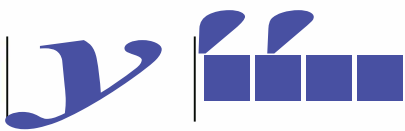

DENTAL AMALGAM FILLING INSTRUMENTS SERRATED PLUGGERS,  
DOUBLE ENDED RESTORATIVE SET OF 6 PCS



DENTAL VISTA TUNNELING SPECULA HALF TITANIUM GOLD COATING SET OF 5 PCS





TAIN 1511 4.0MM  
TAIN 1411 1.7MM



CURETTE & CHALAZION  
(B) ROUND EYE BALL  
11.5CM



TAIN 1111 1MM  
TAIN 1211 2MM  
TAIN 1222 3MM  
TAIN 1311 4MM



CHALAZION & CURETTE  
(B) ROUND EYE BALL  
PLAIN HANDLE 13.5CM



TABH 0786  
BLACKHEAD REMOVER  
13CM



TAHH 3055  
DERMATOLOGY CURETTE  
11CM





GRAVE VAGINAL SPECULA  
 TAEI 1944 75 X 20MM  
 TAEI 1955 95 X 30MM  
 TAEI 1966 105 X 33MM



CUSCO VAGINAL SPECULUM  
 TAEI 0400 75 X 17MM  
 TAEI 0411 80 X 24MM  
 TAEI 0422 80 X 32MM  
 TAEI 0433 90 X 36MM  
 TAEI 0444 110 X 37MM  
 TAEI 0577 100 X 25MM  
 TAEI 0888 115 X 35MM  
 TAEI 0588/1 120 X 17MM  
 TAEI 0588 105 X 27MM  
 SWISS PATTERN



# Steri lized INSTRUMENTS



TATA is approved by SGS for Sterilized Single-use Surgical Instruments. TATA produces top quality single-use surgical instruments in sterile pack.





ISO CERTIFICATES

Certificate PK15/92629.01

The management system of

TATA SURGICAL (PVT) LTD

Mughal Street, Commissioner Road, Muhammad Pura, Sialkot (51310), Pakistan has been assessed and certified as meeting the requirements of

ISO 9001 :2015

For the following activities

Manufacture & Sales of Sterile & Non-Sterile; Single Use & Reusable General Surgical, Dental, Manicure and Pedicure Instruments Design & Manufacturer of Sterile & Non-Sterile single use Electrosurgical Bipolar Forceps with and without Cables.

This certificate is valid from 10 June 2018 until 30 January 2021 and remains valid subject to satisfactory surveillance audits. Recertification audit due a minimum of 60 days before the expiration date Issue 1. Certified since 30 January 2015

The audit leading to this certificate commenced on 24 November 2018 Previous issue certificate validity date was until 30 January 2018 Multiple certificates have been issued for this scope The main certificate is numbered PK15/92629.00

Authorised by

SGS United Kingdom Ltd  
Roosmore Business Park, Ellesmere Port, Cheshire CH65 3EN UK  
T+44 (0)151 350-6666 F+44 (0)151 350-6600

HC SGS 9001 2015 0118  
Page1 of1

SGS



This document is issued by the Company subject to its General Conditions of Certification Services accessible at [www.sgs.com/terms\\_and\\_conditions.htm](http://www.sgs.com/terms_and_conditions.htm). Attention is drawn to the limitations of liability, indemnification and jurisdictional issues established therein. The authenticity of this document may be verified at <http://www.sgs.com/certified-clients-and-products/certified-clients-directory>. Any unauthorized alteration, forgery or falsification of the content or appearance of this document is unlawful and offenders may be prosecuted to the fullest extent of the law.

Certificate PK15/92630.01

The management system of

TATA SURGICAL (PVT) LTD

Mughal Street, Commissioner Road, Muhammad Pura, Sialkot (51310), Pakistan. has been assessed and certified as meeting the requirements of

ISO 13485:2016  
EN ISO 13485:2016

For the following activities

Manufacturer & Sales of Sterile & Non-Sterile; Single Use; Surgical & Ophthalmic Instruments. Design & Manufacturer of Sterile & Non-sterile Single Use Electrosurgical Instruments

This certificate is valid from 30 January 2018 until 30 January 2021 and remains valid subject to satisfactory surveillance audits. Re certification audit due before 28 November 2020 Issue 5. Certified since 30 January 2015

Multiple certificates have been issued for this scope The main certificate is numbered PK15/92630.00

Authorised by

SGS United Kingdom Ltd  
Roosmore Business Park, Ellesmere Port, Cheshire CH65 3EN UK  
T+44 (0)151 350-6666 F+44 (0)151 350-6600 [www.sgs.com](http://www.sgs.com)

SGS 13485 2016 0417  
Page1 of1

SGS



This document is issued by the Company subject to its General Conditions of Certification Services accessible at [www.sgs.com/terms\\_and\\_conditions.htm](http://www.sgs.com/terms_and_conditions.htm). Attention is drawn to the limitations of liability, indemnification and jurisdictional issues established therein. The authenticity of this document may be verified at <http://www.sgs.com/certified-clients-and-products/certified-clients-directory>. Any unauthorized alteration, forgery or falsification of the content or appearance of this document is unlawful and offenders may be prosecuted to the fullest extent of the law.





# CE CERTIFICATE CLASS 2



EC Certificate Production Quality Assurance System: Certificate  
PK1 5/00241 .01

The management system of

**TATA SURGICAL (PVT) LTD**

Mughal Street, Commissioner Road, Muhammad Pura,  
Sialkot (51310), Pakistan.

has been assessed and certified as meeting the requirements of

**Directive 93/42/EEC**  
on medical devices, Annex V

For the following products

The scope of registration appears on page 2 of this certificate

This certificate is valid from 22 March 2018 until 30 January 2023  
and remains valid subject to satisfactory surveillance audits.  
Re certification audit due before 28 November 2020  
Issue 1 Certified since 30 January 2015

Certification is based on scope number P4HR 23887

Multiple certificates have been issued for this scope  
The main certificate is numbered PK1 5/00241 .00

Authorized by

**SGS United Kingdom Ltd, Notified Body 0120**

235 Wile Road, Wiltshire, BA2 0NA UK  
t: +44 (0)1834 522917 f: +44 (0)1834 522937 www.sgs.com

SGS CE 13181 M2

Page 1 of 2



This document is issued by the Company subject to its General Conditions of Certification Services accessible at [www.sgs.com/terms\\_and\\_conditions.htm](http://www.sgs.com/terms_and_conditions.htm). Attention is drawn to the limitations of liability, indemnification and jurisdictional issues established therein. The authenticity of this document may be verified at <http://www.sgs.com/certified-clients-and-products/certified-client-directory>. Any unauthorized alteration, forgery or falsification of the content or appearance of this document is unlawful and offenders may be prosecuted to the fullest extent of the law.

FF0527



EC Certificate Production Quality Assurance System: Certificate  
PK1 5/00241 .01. continued

**TATA SURGICAL (PVT) LTD.**

**Directive 93/42/EEC**  
on medical devices, Annex V

Issue 1

Detailed scope

**Sterile & Non-Sterile. Single Use, General Surgery Scissors, Sterile & Non-Sterile Single Use, General Surgery Dissecting & Tissue Forceps Sterile & Non-Sterile Single Use General Surgery Haemostatic Forceps, Sterile & Non-Sterile Single Use General Surgery Needle Holders Sterile & Non-Sterile Single Use General Surgery Retractors, Sterile & Non-Sterile Single Use General Surgery Suction Tubes, sterile & non sterile surgical cannulas, sterile & non sterile surgical probes, sterile & non sterile single use ophthalmic forceps. sterile & non sterile single use ophthalmic callipers, sterile & non sterile single use ophthalmic hooks, sterile & non sterile single use ophthalmic needle holders, sterile & non sterile single use ophthalmic scissors. sterile & non sterile single use surgical curettes. sterile & non sterile single use Redon Needles. sterile & non sterile single use Scalpel Blade Handles.**

**Annex V Sterility aspects only. Restricted to the aspects of manufacture concerned with securing & maintaining sterile conditions;**

**Sterile single use electro surgical bipolar cables, sterile single use nasal speculum. sterile single use vaginal speculum & sterile single use ophthalmic speculum**

When the above scope includes class II or class I medical devices, a valid CE Type Examination Certificate according to Annex I is a mandatory requirement for each device in order to be placed on the market.



Page 2 of 2

This document is issued by the Company subject to its General Conditions of Certification Services accessible at [www.sgs.com/terms\\_and\\_conditions.htm](http://www.sgs.com/terms_and_conditions.htm). Attention is drawn to the limitations of liability, indemnification and jurisdictional issues established therein. The authenticity of this document may be verified at <http://www.sgs.com/certified-clients-and-products/certified-client-directory>. Any unauthorized alteration, forgery or falsification of the content or appearance of this document is unlawful and offenders may be prosecuted to the fullest extent of the law.

FF0531





 SINGLE  
use  
**SURGICAL**  
INSTRUMENTS

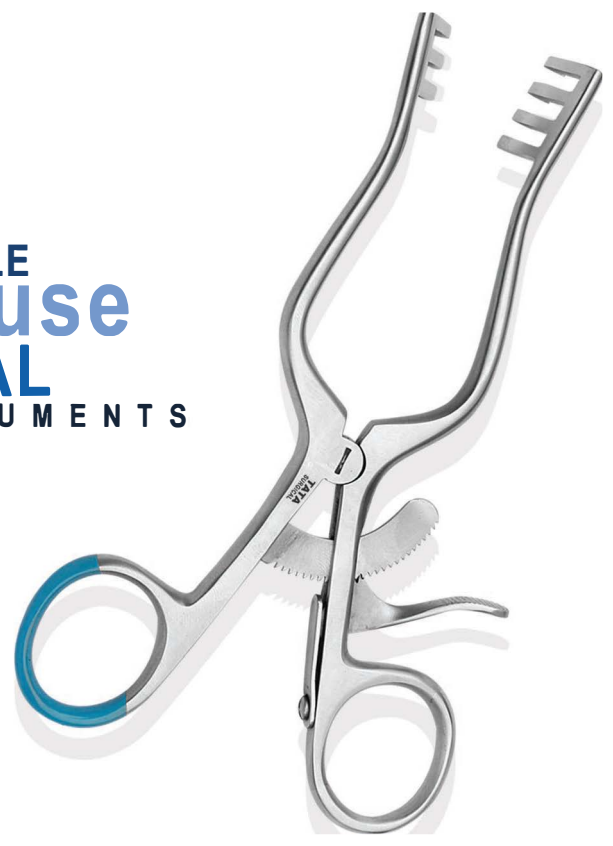

  
**TATA**  
SYMBOL OF QUALITY



 **neu** INDUSTRIES  
SAFER • CLEANER • BETTER

[sales@neuindustries.com](mailto:sales@neuindustries.com)  
[www.neuindustries.com](http://www.neuindustries.com)